



Provided by the author(s) and University of Galway in accordance with publisher policies. Please cite the published version when available.

Title	Treatment of wastewater using an innovative biofilm reactor -- the air suction flow biofilm reactor
Author(s)	Forde, Paul
Publication Date	3-03-14
Item record	http://hdl.handle.net/10379/4246

Downloaded 2024-05-19T21:16:38Z

Some rights reserved. For more information, please see the item record link above.



APPENDIX A

Published abstracts

A.1 An evaluation of the performance and optimisation of a new wastewater treatment technology: The Air Suction Flow Biofilm Reactor.

Paul Forde^{*1}, Eoghan Clifford^{1,2}, Sean Gerrity³, Gavin Collins³, Edmond O' Reilly^{1,2}

¹Civil Engineering, College of Engineering and Informatics, National University of Ireland, Galway, Ireland;

²Ryan Institute for the Environment, Marine & Energy, NUI Galway

³ Department of Microbiology, NUI Galway

* Corresponding author: p.forde2@nuigalway.ie

Abstract

In this study a novel wastewater treatment technology; the Air Suction Flow - Biofilm Reactor (ASF-BR) – a sequencing batch biofilm reactor technology with a passive aeration mechanism, was investigated for its efficiency in removing organic carbon, nitrogen, and phosphorus from high strength synthetic wastewaters. The novel technology was investigated over 2 studies for a total of 430 days. Study 1 of the laboratory study (166 days) operated at a substrate loading rate of 3.60 g filtered chemical oxygen demand (COD_f)/m² media/d, 0.28 g filtered total nitrogen (TN_f)/m² media/d, 0.24 g ammonium-nitrogen (NH₄-N)/m² media/d and 0.07 g ortho-phosphate (PO₄-P)/m² media/d. The average removal rates achieved during Study 1 where 98% COD_f, 86% TN_f, 97% NH₄-N and 35% PO₄-P. During Study 2 (264 days) the unit was operated at a loading rate of 2.49 g COD_f/m² media/d, 0.24 g TN_f/m² media/d, 0.21 g NH₄-N/m² media/d and 0.06 PO₄-P/m² media/d. The energy requirement during this study was reduced through optimisation of the cycle length and the aerobic period. Removal rates in Study 2 averaged 97% COD_f, 88% TN_f, 99% NH₄-N and 76% PO₄-P.

The excess sludge production of the system was evaluated and detailed analyses of the treatment cycles were carried out. Furthermore the design of the ASF-BR enables the control of gaseous emissions produced during the wastewater treatment process. The results indicate that the ASF-BR, and passive aeration technologies can, offer energy efficient alternatives to existing technologies.

Keywords: Biofilm, low energy, sequencing batch biofilm reactor, high strength synthetic wastewater

Paper submitted to *Journal of Environmental Quality* (Under review)

Abstract associate with Chapter 4

A.2 The performance of the Air Suction Flow Biofilm Reactor (ASF-BR) in the treatment of municipal wastewater

E. Clifford^{*,1,2}, P. Forde¹, S. McNamara¹, M. Rodgers¹, E. O'Reilly^{1,2},

¹ Civil Engineering, NUI Galway;

² Ryan Institute, NUI Galway

* Corresponding author: eoghan.clifford@nuigalway.ie

Abstract

The provision of technologies that can meet increasingly stringent wastewater discharge standards while reducing energy, operation, and maintenance costs is vital to government, local authorities, industry, and the public at large. The air suction flow biofilm reactor (ASF-BR) is a novel batch biofilm technology suitable for treating wastewaters from municipal, industrial, and agricultural sources. This paper presents an investigation into the performance of a laboratory-scale ASF-BR in treating municipal-strength wastewater over two operational periods—Phase 1 and Phase 2. Phase 1 concentrated on organic carbon removal and nitrification, whereas Phase 2 included an anoxic step to achieve denitrification. The operation of the unit was also investigated by monitoring organic carbon and nitrogen in the reactors during a number of treatment cycles. In Phases 1 and 2 (29 and 124 days of steady-state operation, respectively) of this laboratory study, using a municipal-strength synthetic wastewater, the average influent total chemical oxygen demand (COD_t) was 288 and 313 mg/L, whereas the average influent filtered COD (COD_f) was 127 and 148 mg/L, respectively. The average COD_f removal rates were 92 and 79% during Phases 1 and 2, respectively. Average nitrogen removals during Phases 1 and 2 of greater than 95% ammonium nitrogen (NH₄-N) were achieved. By reducing the number of pumping cycles during the aerobic step, the overall energy consumed was reduced by 37.5% during Phase 2 while achieving similar results. On the basis of these positive initial results, a pilot-scale reactor has been constructed at a local wastewater-treatment facility, and commissioning of the unit is currently underway.

Keywords: Air Suction Flow –Biofilm Reactor, decentralised wastewater treatment, attached growth, nitrification, passive aeration, ASF-BR

Paper published: *Journal of Environmental Engineering*, 139(6), pp. 864-872.

A.3 Nitrous oxide production from the biological treatment of municipal wastewater and landfill leachate using the ASF-BR

Paul Forde^{*1}, Eoghan Clifford^{1,2}.

¹Civil Engineering, College of Engineering and Informatics, National University of Ireland, Galway, Ireland;

²Ryan Institute, NUI Galway

* Corresponding author: p.forde2@nuigalway.ie

Abstract

In this study the nitrous oxide (N₂O) emissions from biological treatment of municipal wastewater (Study 1) and landfill leachate (Study 2) using an innovative batch biofilm wastewater treatment process, the Air Suction Flow – Biofilm Reactor (ASF-BR), was evaluated.

During the 2 phases of Study 1 (S1) influent filterer chemical oxygen demand (COD_f)/filtered total nitrogen (TN_f) ratios averaged 1.9 (Phase S1a) and 30.9 (Phase S1b) respectively. Nitrate (NO₃-N) removals, during the anoxic period, averaged 49% and 93% respectively for Phases S1a and S1b. Average N₂O production rates decreased from 0.00019 mg N₂O/l/min and 0.12 g N₂O/NO₃-N removed (Phase S1a) to 0.00014 mg N₂O/l/min and 0.18 g N₂O/NO₃-N (Phase S2b). On the commencement of the aerobic period the production of N₂O declined and there was no observed N₂O emission after 30 minutes of the aerobic step.

Study 2 consisted of 3 phases; Phase S2a. Phase S2b and Phase S2c. In Phase S2a it was observed that 95% of the carbon in the leachate (measured as COD_f) was found to be non-biodegradable which inhibited the denitrification of the leachate. Thus an external carbon was added to influent leachate in Phase 2b at a rate of 2.4 g C₆H₁₂O₆/l resulting in N₂O production of 0.0003 mg N₂O/l/min and 0.006 g N₂O/NO₃-N. During Phase S2c the mass of glucose added was increased to 20 g C₆H₁₂O₆/l which resulting a N₂O production rate of 0.0003 mg N₂O/l/min and 0.001 g N₂O/NO₃-N which increased the NO₃-N removal to 13%. During Phase S2b and Phase S2c it was observed N₂O continued to be released during the aerobic period which may imply that simultaneous nitrification and denitrification and or nitrifier denitrification was occurring.

The ASF-BR can offer a potential method of controlling and monitoring the emission of N₂O during the wastewater treatment process or evaluating, on a pilot scale, the emissions from various types of wastewaters.

Keywords: Air Suction Flow –Biofilm Reactor; biofilm; N₂O; municipal wastewater; landfill leachate.

Paper submitted to *Biodegradation* (Under review)

Abstract associate with Chapter 7

A.4. Performance and optimisation of a new wastewater technology: The Air Suction Flow Biofilm Reactor.

Paul Forde*, Michael Rodgers, Salvador McNamara, Edmond O Reilly, Eoghan Clifford,

Civil Engineering, College of Engineering and Informatics, NUI, Galway, Ireland

* Corresponding author: p.forde2@nuigalway.ie

Abstract

A novel wastewater treatment technology the Air Suction Flow - Biofilm Reactor (ASF-BR), has been developed for the removal of organic carbon, nitrogen, and phosphorus from industrial, agricultural and high strength wastewaters. The technology comprises 2 identical and sealed reactors, each containing plastic media that support biofilm growth. The ASF-BR operates on the principles of a sequencing batch biofilm reactor with distinct steps such as; fill, anaerobic, anoxic, aerobic, settle and decant or any combination thereof. Aeration is carried out by sequentially moving wastewater, between the two reactors using a partial vacuum. This passive aeration process alternately exposes the biofilm in each reactor to air as the wastewater is circulated between the two reactors; and removes the requirement for mechanical aeration or compressed air. As the reactors are sealed, gases produced during the wastewater treatment process can be re-circulated into the reactors or drawn off during treatment cycles. This control offers the opportunity for greenhouse or odorous gas emissions to be significantly reduced.

In this study a laboratory scale ASF-BR was trialled for its efficacy in treating high strength synthetic wastewater. During Phase 1 of the study (166 days) at substrate loading rates of 2.74 g filtered chemical oxygen demand (COD_f)/m² media/day, 0.26 g filtered total nitrogen (TN_f)/m² media/day and 0.22 g ammonium nitrogen (NH₄-N)/m² media/day, removal rates of 97.8% COD_f, 88.5% TN_f and 98.4% NH₄-N were achieved. This equates to removals of 2.69 g COD_f/m² media/day, 0.23 g TN_f/m² media/day and 0.22 g NH₄-N /m² media/day.

Phase two of the study (264 days) focused on reducing the energy requirement of the treatment process by optimising the frequency of wastewater circulations during the aeration cycle. At an organic loading rate of 2.54 g COD_f/m² media/d, 0.26 g TN_f/m² media/d and 0.22 g NH₄-N/m²media/d removal rates of 97.2% COD_f, 88.5% TN_f and 98.5% NH₄-N equivalent to 2.47 g COD_f /m² media/d, 0.21 g TN_f/m² media/d and 0.22 g NH₄-N/m² media/d were achieved.

The results indicate ASF-BR may offer a low energy alternative to existing technologies and allow for greenhouse and odorous gas emissions to be controlled from wastewater treatment facilities.

Invited for oral presentation at the IWA 2nd Development and Exhibition, Kuala Lumpur, 21st-24th November 2011.

Abstract associated with Chapter 4

A.5 Treatment of municipal strength wastewater using a novel air Suction Flow Biofilm Reactor: Performance and optimisation.

E. Clifford^{*,1}, S. McNamara¹, P. Forde^{1,*}, M. Rodgers¹, E. O'Reilly¹

¹ Civil Engineering, NUI Galway; * Corresponding author: eoghan.clifford@nuigalway.ie

Keywords

Air suction flow biofilm reactor, decentralised wastewater treatment; attached growth; nitrification; low energy, ASF-BR

Abstract

The provision of technologies that can meet increasingly stringent wastewater discharge standards while reducing energy, operation and maintenance costs is vital to government, local authorities, industry and the public at large. The air suction flow biofilm reactor (ASF-BR) is a novel technology, suitable for treating wastewaters from municipal, industrial and agricultural sources. The innovative technology comprises; (i) two sealed reactors containing plastic media upon which bacteria grow, (ii) a vacuum pump (iii) motorised valves and (iv) simple automated control. Furthermore the use of sealed reactors means, gases developed during the biological processes can be captured and treated within the reactor itself or using an ancillary gas and odour treatment system. Biological wastewater treatment is achieved by moving wastewater between the two reactors using a partial vacuum, alternately induced in each reactor, with a vacuum pump. No diffusers, aerators or compressors are required. Biofilm, developing on the plastic media are passively aerated thus eliminating the need for mechanical aeration and stirring which can be inefficient and energy intensive processes. The process is controlled and monitored remotely using a bespoke program logic controller (PLC) and supervisory control and data acquisition (SCADA) program.

In Phases 1 and 2 (51 and 161 days respectively) of this laboratory study, using a municipal strength synthetic wastewater, influent total chemical oxygen demand (COD_T) averaged 288 mg/l (Phase 1) and 306 mg/l (Phase 2). Surface area loading rates averaged 1.3 g COD/m^2 media/day and 2.0 g COD/m^2 /day during Phases 1 and 2, respectively. Average effluent concentrations of 29 mg/l filtered COD (COD_F) – Phase 1 – and 25.6 mg COD_F/l (Phase 2) were observed. Average removals, during Phases 1 and 2, of > 95 % ammonium-nitrogen (NH_4-N) were achieved while energy costs per m^3 wastewater treated were reduced by 37.5 % during Phase 2.

Based on these positive initial results, pilot scale reactors have been constructed at a local wastewater treatment facility and commissioning of the unit is currently underway. Further work will focus on nitrogen and phosphorous removal, pilot scale studies and a detailed study on biofilm sloughing and effluent suspended solids.

Invited for oral presentation at the IWA Biofilm conference 2011: Processes in biofilms, 27th-30th October 2011.

APPENDIX B

Analytical methods

B Analytical methods

The analytical procedures and methods used in the testing of various parameter contained in the wastewater and the gases monitored during the course of the study are presented herein.

B 1 Analysis using titration

B 1.1 Chemical oxygen demand (COD)

COD of the wastewater was measured using a Closed Reflux Titimetric Method in accordance the Standard Methods for the Examination of Water and Wastewater (1995), method 5220-C. Pre prepared Lovibond (Amesbury, UK) test vials were purchased from Lennox Laboratories Ltd. (Dublin). Each vial contained a mixture of potassium dichromate ($K_2Cr_2O_2$) and ferrous ammonium sulphate (FAS) with the volume of each determine by the range of the test (0-150 mg/l; 0-1500 mg/l; 0-15000 mg/l). A HACH DR/2000 spectrometer was then used to measure the concentration of the COD of the sample. Results were given in mg COD/l.

B 1.2 Total nitrogen (TN)

The TN gave a measure all the nitrogen in a sample. During the study on synthetic high strength wastewater the TN present in the wastewater samples was measured using the HACH TNT Persuphate Digestion Method (Method 10071) using a HACH DR/2000 spectrometer. Results were expressed in mg/l.

B 2 Analysis using a Konelab 20 Nutrient Analyser

B 2.1 Ammonium nitrogen (NH_4-N)

The NH_4-N contained in wastewater samples was tested using a Thermo Clinical Labsystems, Konelab 20 Nutrient Analyser. The analyser works on the principle of the reaction of Ammonia with salicylate and dichloroisocyanurate in the presence of sodium nitroprusside to form a blue colour that is proportional to the amount of Ammonia present. The colour produced is then measured at 660 nm. The reagents used were sourced from Serosep Ltd., Limerick. The results were given in mg NH_4-N/l .

B 2.2 Nitrite-nitrogen (NO_2-N)

The NO_2-N in the wastewater samples was tested using Thermo Clinical Labsystems, Konelab 20 Nutrient Analyser. The principle behind the test is the reaction of nitrite ions with a reagent containing sulphanilamide and N-(1-naphthyl)-ethylenediamine dihydrochloride to

produce a highly coloured azo dye that is measured photometrically at 540nm. The reagents used were sourced from Serosep Ltd., Limerick. The results were given in mg NO₂-N/l.

B 2.3 Nitrate-nitrogen (NO₃-N)

NO₃-N was measured using a Thermo Clinical Labsystems, Konelab 20 Nutrient Analyser. The principle behind the analysis is the reduction of Nitrate to Nitrate using hydrazine sulphate. The nitrate ions produced and those originally present are determined by diazotisation with sulphanilamide and coupling with N-(1-naphthyl)-ethylenediamine dihydrochloride. The azo coloured dye is then measured photometrically at 540 nm. The reagents used were sourced from Serosep Ltd., Limerick. This procedure measured the Total oxidised nitrogen (TON) present. The NO₃-N was then determined by subtracting the NO₂-N from the TON. The results are presented in mg NO₃-N/l.

B 2.4 Orthophosphate-phosphorus (PO₄-P)

The PO₄-P was measured using a Thermo Clinical Labsystems, Konelab 20 Nutrient Analyser. The principle behind the analysis is the reaction of orthophosphate with ammonium molybdate and antimony potassium tartrate under acidic to form a complex solution which when reduced under acidic conditions produces an intense blue colour. The colour produced is then measured photometrically at 880 nm (or 660 nm). The absorption is proportional to the amount of orthophosphate in the sample. The reagents used were sourced from Serosep Ltd., Limerick. The results are presented in mg PO₄-P/l.

B 3 Testing procedure using the Biotector Analyser

The addition of a Biotector Analyser to the repository of testing equipment in the laboratory enable addition tests to be carried out on the wastewater samples. The Biotector (Biotector, Cork) is a patented online analyser capable of measuring Total Nitrogen (TN), Total organic carbon (TOC), Total inorganic carbon (TIC) and Total Phosphorus (TP).

B 3.1 Total organic carbon (TOC)

The principles of the TOC test using the Biotector is based on the addition of acid to lower the pH before the TIC is sparged off as CO₂. Oxidation is then used to achieve total and complete oxidation of the sample including organic carbon to CO₂, nitrogen compounds to nitrate and phosphorus compounds to phosphate. The oxidation method utilises hydroxyl radicals generated within the analyser by combining oxygen, which passed through an ozone

generator, with sodium hydroxide. The CO₂ is sparged and measured by a NDIR detector. The result of this measurement is then converted to the equivalent TOC reading which is given in mg TOC/l.

B 3.2 Total inorganic carbon (TIC)

TIC was measured as part of the TOC analysis. The addition of sulphuric acid which causes the TIC to be sparged off from the sample as CO₂. This sparged CO₂ is measured and a reading is given in mg TIC/l.

B 3.3 Total phosphorus (TP)

To obtain the measure of the TP using the Biotector, acid is added to the sample of wastewater to lower the pH before the TIC is sparged off as CO₂. Oxidation is then used to achieve total and complete oxidation of the sample including organic carbon to CO₂, nitrogen compounds to nitrate and phosphorus compounds to phosphate. The oxidation method utilises hydroxyl radicals generated within the analyser by combining oxygen, which passed through an ozone generator, with sodium hydroxide. The sample then undergoes an acid boiling at 100°C for 20 minutes, breaking down the polyphosphate bonds into ortho-phosphates. The sample of the wastewater is then reacted with a Vanadate-Molybdate reagent at 70°C to produce an acidic compound. The spectrophotometer then analyses the sample at wavelengths applicable to ortho-phosphates within the selected range. The result is then displayed as mg TP/l.

B 3.4 Total nitrogen

To obtain a measure of the TN of a sample the tests described in B 3.2 and B 3.3 had to be conducted to obtain an oxidised sample of the wastewater. The oxidised sample was transferred from the reactor to a measuring cell where a spectrometer analyses applicable to nitrates. The result is the given in mg TN/l.

B 4 Analysis using probes and meters

B 4.1 Dissolved oxygen

DO was measured using a Wissenschaftlich Technische Werstätten (WTW) Cellox 325 electrode which was connected to a WTW 350i multimeter. The probe was inserted into the wastewater contained within the reactor through one of the manual sampling valves on the lid of each of the reactors. Results from the meter were given in mg/l.

B 4.2 pH

The pH of the wastewater was measured using a Wissenschaftlich Technische Werstätten (WTW) pH Electrode Sen Tix 41 probe connected to a WTW 350i. The probe was inserted into the wastewater contained within the reactor through one of the manual sampling valves on the lid of each of the reactors. Results from the meter were given in mg/l.

B 4.3 Nitrous oxide (N₂O)

A ViaSensor G200 meter (Q Instrument Services Limited, Cork, Ireland) was used for the measurement of N₂O. The ViaSensor G200 meter measures N₂O in gaseous form. The reading on the meter were given in part per million (ppm) of the N₂O present in the gas samples. The readings were subsequently converted to mg/l using the Ideal Gas Law derived from Boyles Law and Charles Law (Tchobanoglous et al., 2004):

$$PV = nRT \quad [Eqn. B1]$$

where: P is the absolute pressure, atm; V is the volume occupied by the gas; n is the number of moles of the gas; R is the universal gas law constant (0.000082057 atm·m³/mole·K and T is the temperature.

All N₂O samples were tested at atmospheric pressure with an average temperature of 11°C.

B 5 Analysis of solids concentration

B 5.1 Suspended solids (SS)

The SS of a sample measures the non-filterable residue of the sample. The test was carried out in accordance with the Standard Methods for the Examination of Water and Wastewater (1995), Method 2540-D. Measurements were taken in milligram before being converted to mg/l using the following equation:

$$\frac{m_2 - m_1}{v} \times 1000 = mg \text{ SS}/l \quad [Eq. B2]$$

where: m₁ is the initial weight of the filter paper before filtration; m₂ is the weight of the following filtration and drying in an oven for 24 hours at 105°C; v is the volume of the wastewater sample which was filtered.

B 5.2 Sludge volume index (SVI)

Sludge volume index (SVI) tests were carried out in accordance with Standard Methods for the Examination of Water and Wastewater, Method 2710 D (APHA, 2005) but without the use of stirring. The SVI was determined using Eq. B2:

$$\frac{SS_v}{SS} \times 1000 = l/mg \quad [Eq. B3]$$

where: SS_v is the volume of settled sludge in a 1 litre graduated cylinder after 30 minutes; SS is the suspended solids of the sample.

APPENDIX C

Operation of the pilot scale ASF-BR

C 1 Background

The Air Suction Flow Biofilm Reactor (ASF-BR) operated on the principles sequencing batch biofilm reactor (SBBR) with five distinct stages in the treatment process: (i) fill, (ii) anoxic/anaerobic, (iii) aerobic, (iv) settlement and (v) discharge. The operation of the unit was controlled using a ControlStar Supervisor Control and data acquisition (SCADA) control system along with a ControlStar Program Logic Controller (PLC). The program used in the control process was developed by the design team in the Engineering Department of NUI Galway. ControlStar then translated the program into a fusion programming language, which is a graphically based program developed by ControlStar, which is compatible with the PLC used.

The benefits associated with using the ControlStar system include:

- a. User friendly computer interface of the ControlStar operating system is graphically based enabling demonstration to students on how the wastewater is treated process takes place;
- b. The program can be remotely monitored via an internet connection. In practise this would allow several treatment to be managed from a centralised location;
- c. SCADA system maintains a log of all “events” which occur in the ASF-BR for a three month period. Events refer to when something happens in the unit, ie a valve opens or closes, a level switch is tripped or released or when the vacuum pump is operating. This log allows the cause problems with the treatment process to be easily identifiable.

C 2 Overview of the ControlStar operating system

The PLC programme was developed to operate 2 independent ASF-BR units (ASF-BR 1 and ASF-BR 2) which were termed “Nitrogen Removal” and “Phosphorus Removal” purely for identification purposes.

Upon logging into the ControlStar program the user is greeted the ControlStar user interface (Figure G 1). The main screen shows a pictorial representation of one of the ASF-BR units (Node 1, Nitrogen removal corresponding to ASF-BR 1).

In this screenshot the valves and the vacuum pump are highlight green indicating that they are active. On the left hand side of the screen there are three black rectangles, these indicate connectivity with the PLC. When the computer is connected to the PLC either via the internet on a cable these alternate between green, yellow and red. Below these rectangles there is an option to log into the programme which allows the user to make changes to the operational configuration. At the bottom of the screen is fault achieve.

C 2.1 Operation of the ControlStar Program

The program is managed using options contained within the three tabs on the left of the screen

C 2.1.1 Mimics tab

Selecting the first tab on the left hand side of the screen “*Mimics*” presents four additional tabs (Figure G 2 a).

C 2.1.1.1 Main mimic

The “*Main Mimic*” displays a pictorial representation of the Node 1 – Nitrogen Removal (ASF-BR 1).

C 2.1.1.2 Events

The “*Events*” tab gives a record of all events which take place in both ASF-BRs (Figure C 3).

C 2.1.1.3 Trend

The “*Trend*” tab allows graphs to be developed of how long each of the events lasted,

C 2.1.1.4 Node 2

The “*Node 2*” tab gives a pictorial representation of ASF-BR 2 – Phosphorus removal (ASF-BR 2) (Figure C 2 b).

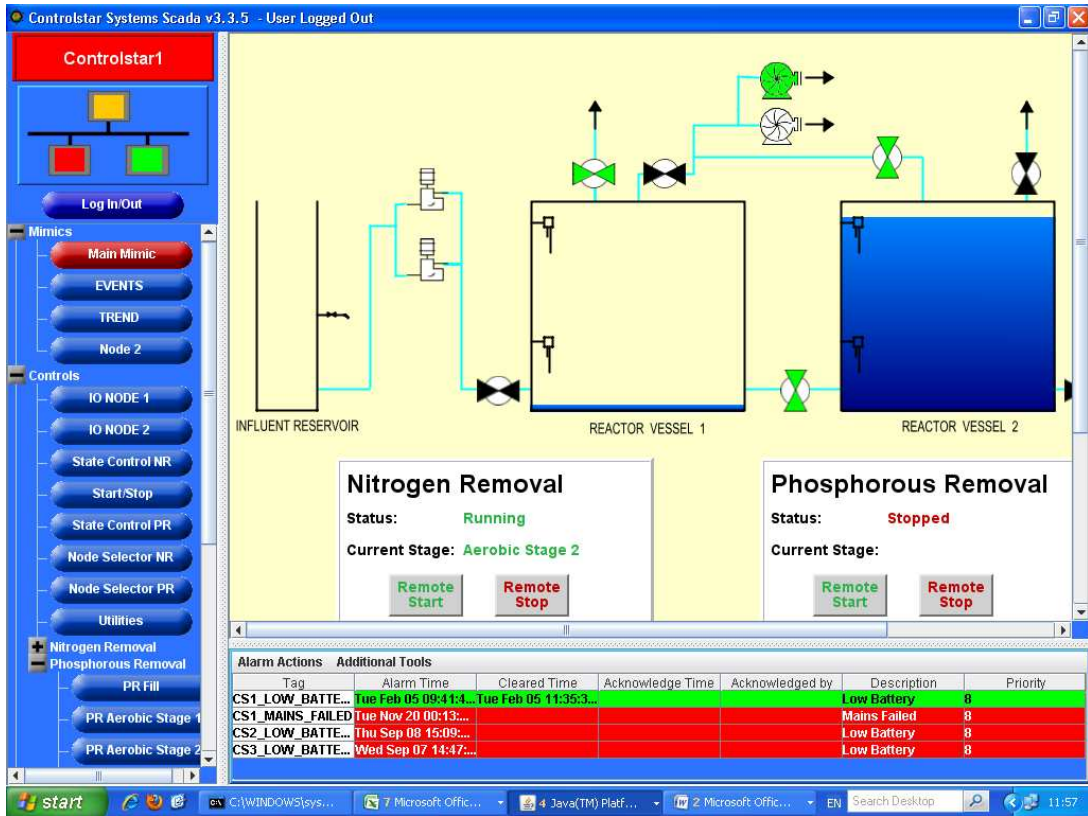

Figure C1 Node 2 – ASF-BR 1

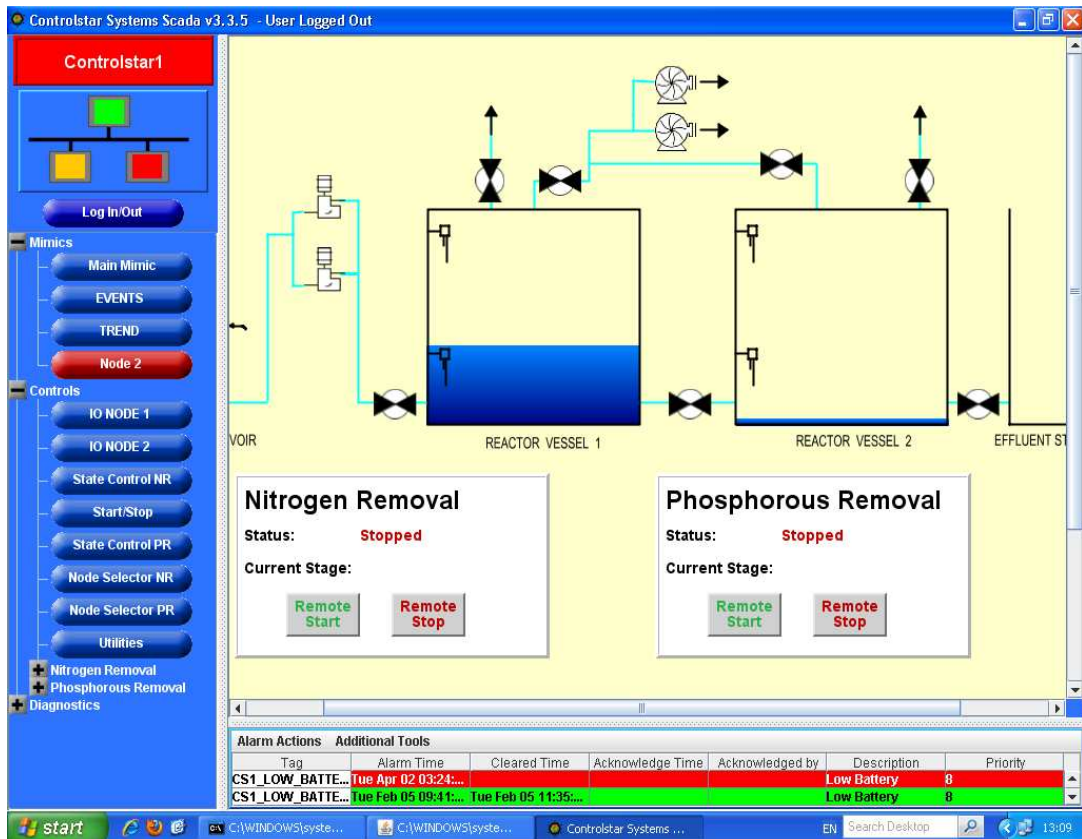

Figure C2 Node 2 (both units stopped)



Figure C3 Events log

C 2.1.2 Controls tab

The “Control” tab contains links to 8 further tabs. IO Node 1 and IO Node 2 refer the IO function blocks controlling Node 1 (ASF-BR 1) and Node 2 (ASF-BR 2) respectively.

C 2.1.2.1 IO Node 1 and IO Node 2

The program was designed to allow the digital outputs (controlling valves, pumps and blowers) to be set in fixed states for a period of time, or until a certain condition is reached such as a level switch being activated. Each state equates to a step in the treatment process.

Each of the Input output (IO) configuration consists of a Node which consists of two 4-channel analogue input modules, two 8-channel digital output modules, and one 16-channel digital input module (Figure G 4). The IO used in the initial configuration is as follows:

1. Digital outputs controlling the valves.
2. Digital output controlling the air blower.
3. Digital output controlling the inlet /outlet pump if required.
4. Digital inputs taking the inputs from the level switches.

- Analogue inputs, which are ready for the future study when dissolved oxygen sensors are used.

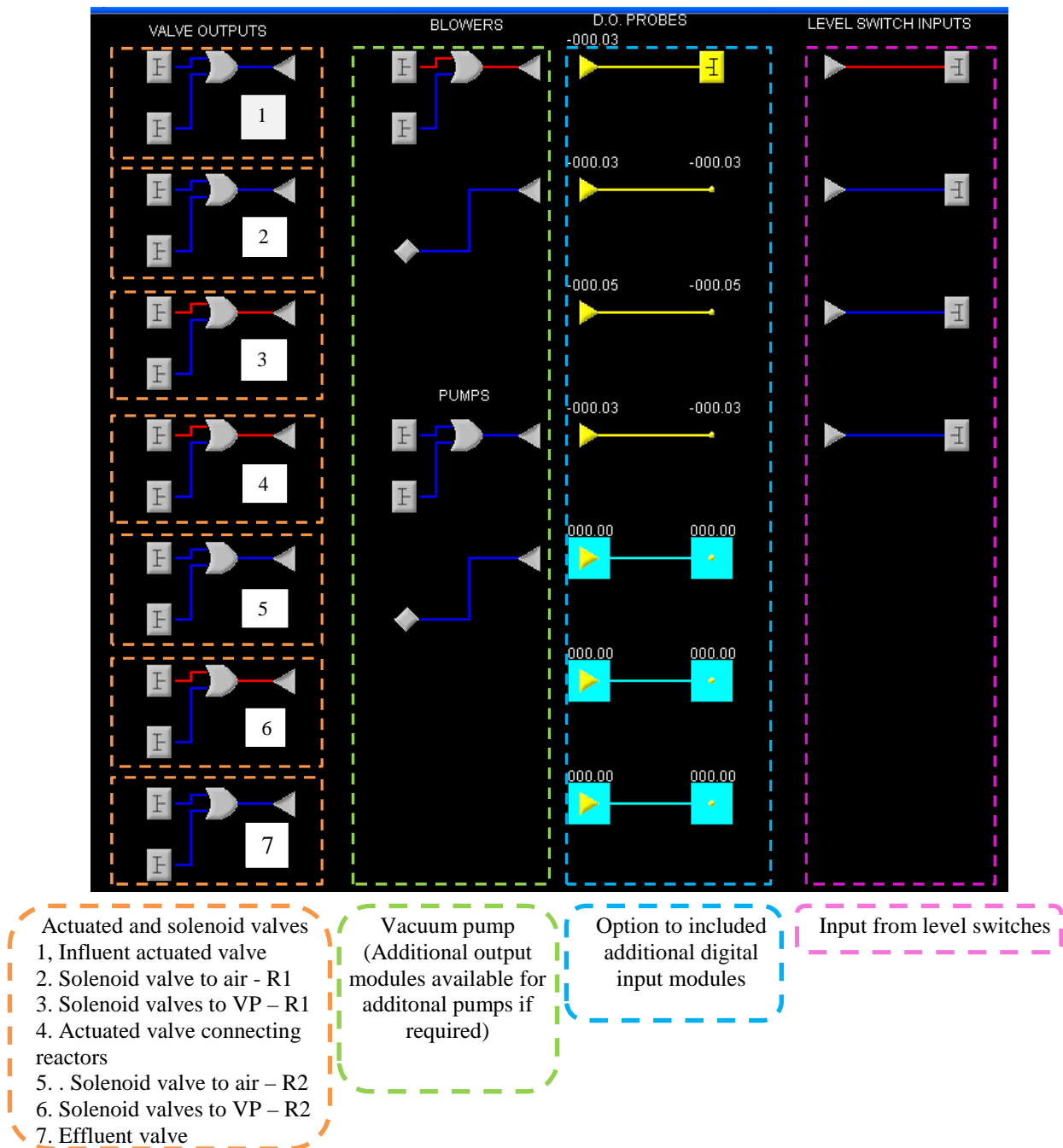

Figure C4 IO function blocks directly bound to a node as shown in the SCADA screen.

Note; The red lines indicate that the function block is active. In this case the active step is Aerobic Step 6 described in Table 3.2 (Section of screenshot shown for clarity)

C 2.1.2.2 State Control NR

The *State Control NR* tab contains a truth table which dictates the state of each of the mechanical components during each event in the treatment process.

	1	2	3	4	5	6	7	8	9	10	11	12	13	14	15	16
CS1_PR_FILL	✓	✗	✓	✗	✗	✗	✗	✗	✓	✗	✗	✗	✗	✗	✗	✗
CS1_PR_AERO1	✗	✓	✗	✓	✗	✓	✗	✗	✗	✗	✗	✗	✗	✗	✗	✗
CS1_PR_AERO2	✗	✓	✗	✓	✓	✗	✗	✗	✓	✗	✗	✗	✗	✗	✗	✗
CS1_PR_AERO3	✗	✗	✗	✗	✗	✗	✗	✗	✗	✗	✗	✗	✗	✗	✗	✗
CS1_PR_AERO4	✗	✓	✗	✓	✗	✓	✗	✗	✗	✗	✗	✗	✗	✗	✗	✗
CS1_PR_AERO5	✗	✗	✓	✓	✗	✓	✗	✗	✓	✗	✗	✗	✗	✗	✗	✗
CS1_PR_AERO6	✗	✗	✗	✗	✗	✗	✗	✗	✗	✗	✗	✗	✗	✗	✗	✗
CS1_PR_ANAERO	✗	✗	✗	✗	✗	✗	✗	✗	✗	✗	✗	✗	✗	✗	✗	✗
D300010438	✗	✗	✗	✗	✗	✗	✗	✗	✗	✗	✗	✗	✗	✗	✗	✗
D300010449	✗	✗	✗	✗	✗	✗	✗	✗	✗	✗	✗	✗	✗	✗	✗	✗
CS1_PR_SETTLE	✗	✗	✗	✗	✗	✗	✗	✗	✗	✗	✗	✗	✗	✗	✗	✗
CS1_PR_EMPTY	✗	✗	✗	✗	✗	✓	✓	✗	✗	✗	✗	✗	✗	✗	✗	✗
D30001047C	✗	✗	✗	✗	✗	✗	✗	✗	✗	✗	✗	✗	✗	✗	✗	✗
D30001048D	✗	✗	✗	✗	✗	✗	✗	✗	✗	✗	✗	✗	✗	✗	✗	✗
D30001049E	✗	✗	✗	✗	✗	✗	✗	✗	✗	✗	✗	✗	✗	✗	✗	✗
D3000104AF	✗	✗	✗	✗	✗	✗	✗	✗	✗	✗	✗	✗	✗	✗	✗	✗

- 1. Actuated influent valve
- 2. Solenoid valve to air, R1
- 3. Solenoid valve to VP, R1
- 4. Actuated valve connecting R1 & R2
- 5. Solenoid valve to VP, R2
- 6. Solenoid valve to air, R2
- 7. Actuated influent valve

Figure C5 Truth table indicating the state of valve and vacuum pump during each event in the treatment process

C 2.1.2.3 Start/stop tab

The “Start/Stop” tab allows the user to define the treatment cycle duration and the minimum number of aeration events.

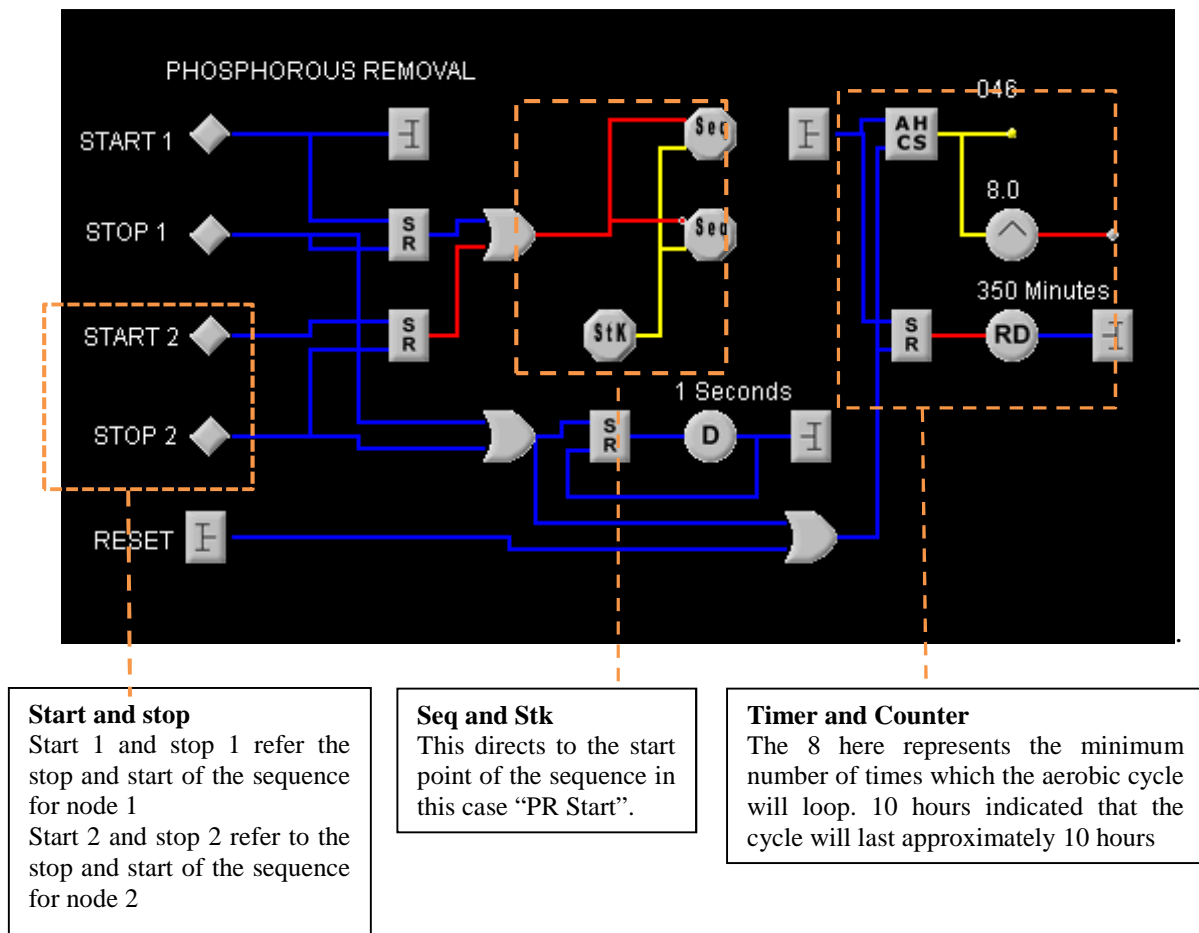

Figure C6 Node selection Program for Phosphorus Removal PLC program as configured for the pilot scale unit

Note: Section of screenshot shown for clarity

C 2.1.2.4 Node Selector NR and Node Selector PR tabs

These tabs indicate the state of each of the IO signals within each of the function blocks.

C 2.1.2.5 Utilities tab

The “Utilities” tab indicates the power source being used by both ASF-BRs. The unit has the option of having a secondary power supply in the form of a battery to ensure the units can remain operational in the event of a mains power failure.

C 2.1.2.6 Nitrogen removal/Phosphorus removal tabs

The “Nitrogen removal” tab and “Phosphorus removal” tab shows each of the step which occurs during a treatment cycle.

Each step is cycled through as per the overall program parameters chosen. Within each step there is the ability to define several time parameters (Figure C 7).

- Delay in activation of this step following the completion of the previous step;
- The default duration of the step if a signal to terminate a step is not received;
- If controlled by a level switch or a sensor, delay in triggering the next step from reaching the set point.

The screenshot displays the Controlstar Systems Scada v3.3.5 interface. On the left, a navigation tree shows the 'PR Fill' process selected. The main window features a ladder logic diagram for the 'PR Fill' process, with steps 00 through 13. Annotations explain the timing: 'A time delay before the event begins' (0 Seconds), 'Default time: If a signal terminate the event is not received after this time, the event will be terminated' (1 Minutes), and 'Time for which the event will last after a signal has been received to terminate the event' (1 Seconds). A box labeled 'Steps in the treatment cycle' points to the sequence of steps. At the bottom, an 'Alarm Actions' table is visible.

Tag	Alarm Time	Cleared Time	Acknowledge Time	Acknowledged by	Description	Priority
CS1_LOW_BATTE...	Tue Feb 05 09:41:4...	Tue Feb 05 11:35:3...			Low Battery	8
CS1_MAINS_FAILED	Tue Nov 20 00:13:...				Mains Failed	8
CS2_LOW_BATTE...	Thu Sep 08 15:09:...				Low Battery	8
CS3_LOW_BATTE...	Wed Sep 07 14:47:...				Low Battery	8

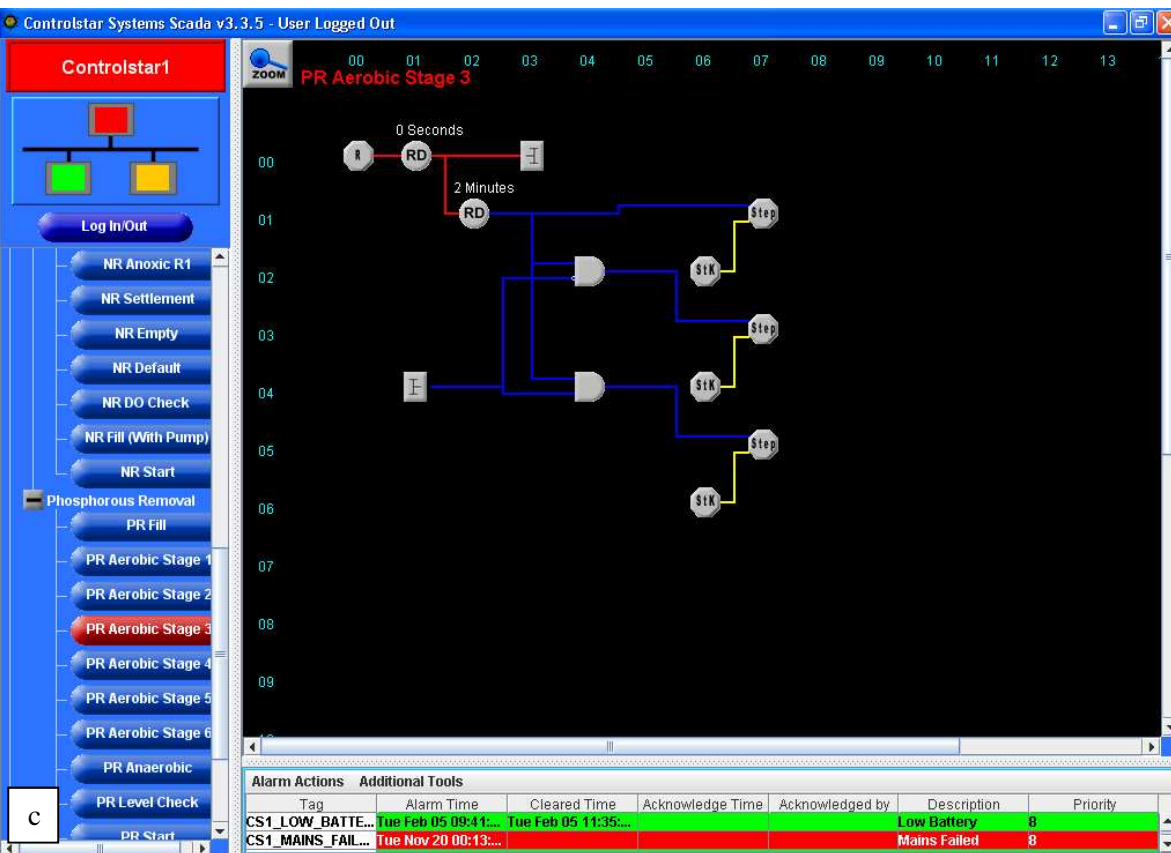
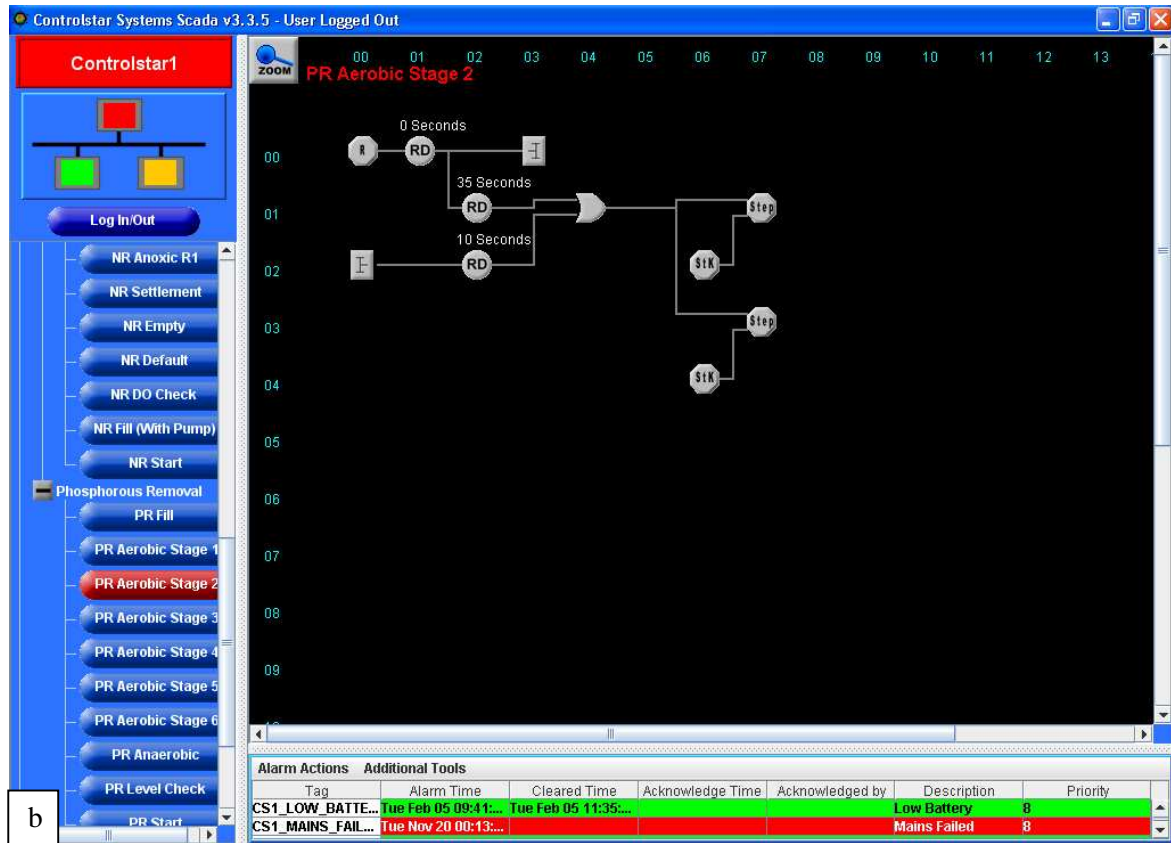

Figure C7 - Setting the duration of each event; (a) fill event (Step 1, Table 3.1); (b) wastewater drawn to R2 (Step 3, Table 3.1); (c) wastewater is held in R2; (Step 4, Table 3.1)

Note: These screen shots are for illustrative purposes and do not reflect the logic of the treatment cycle. The treatment cycles occur in accordance with Table 3.1 - Chapter 3

The duration of each of the events was defined by selecting the timing block labelled RD, and selecting “Change parameters” (Figure C 8 a). A window then opens which allows the operator to specify the duration of the event (Figure C 8 b).

The screenshot displays the Controlstar Systems Scada v3.3.5 interface. The main window shows a ladder logic diagram for 'PR Aerobic Stage 2'. The diagram includes a 'Change Parameters Force' block with a 'RD' (Reset Delay) block. The 'RD' block is highlighted, and a window is open to specify the duration of the event. The table below shows alarm actions for 'Low Battery'.

Tag	Alarm Time	Cleared Time	Acknowledge Time	Acknowledged by	Description	Priority
CS1_LOW_BATTE...	Tue Apr 02 03:24:...				Low Battery	8
CS1_LOW_BATTE...	Tue Feb 05 09:41:...	Tue Feb 05 11:35:...			Low Battery	8

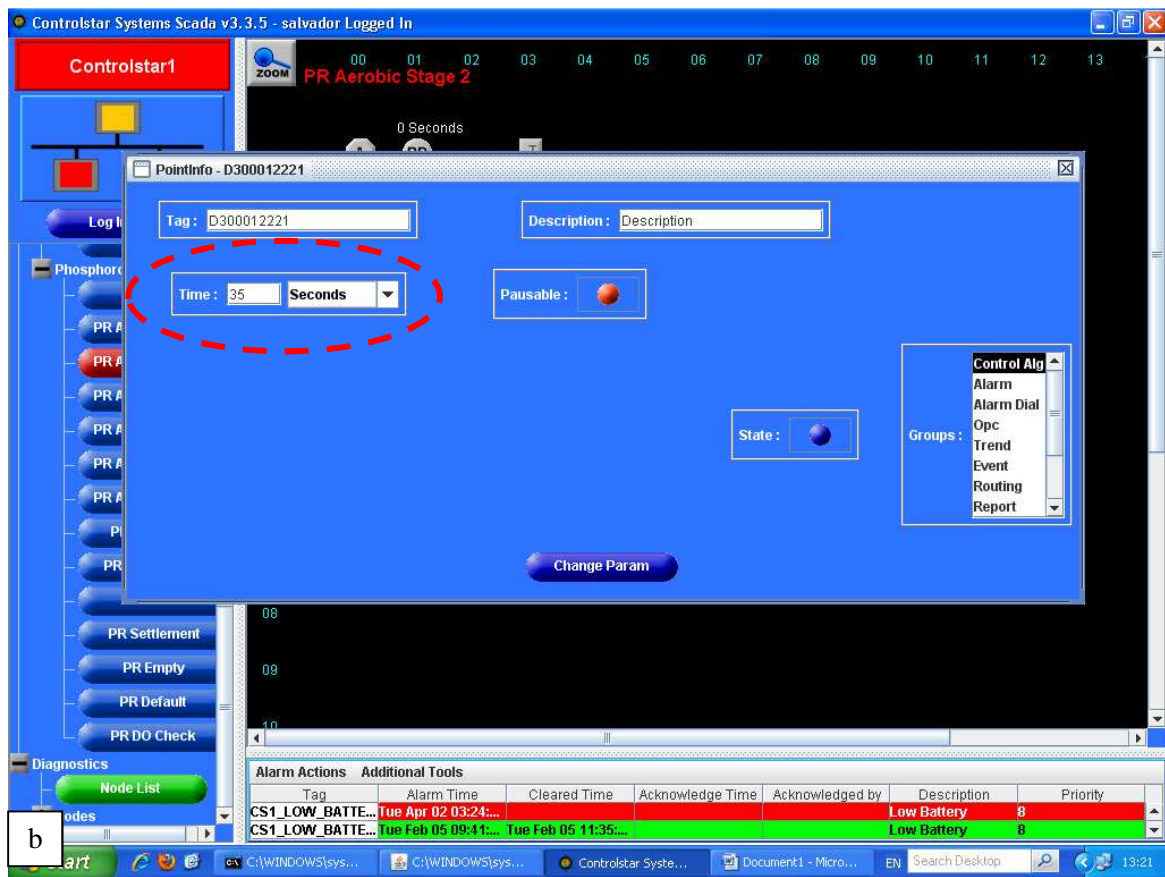

Figure C8 Defining the during of each step in the treatment cycle

APPENDIX D

High strength synthetic wastewater treatment results

D 1.1.1 Influent wastewater - Study 1 - Phase 1

Date	Day No.	SS	COD	COD _f	TN	TN _f	NH ₄ -N	TON	N ₀₂ -N	N ₀₃ -N	PO ₄ -P
		mg/l	mg/l	mg/l	mg/l	mg/l	mg/l	mg/l	mg/l	mg/l	mg/l
11/03/10	1	143	2436	2428	164	128	85.40	1.00	0.70	0.30	44.18
12/03/10	2	115	2416	2334	144	118	86.60	0.25	0.10	0.15	45.07
16/03/10	7	188	1686	1302	196	144	79.30	0.11	0.10	0.01	30.44
17/03/10	7	244	1650	1308	198	168	93.60	0.70	0	0.70	30.79
18/03/10	8	147	2140	1998	-	-	82.70	0.11	0.11	0	27.55
19/03/10	10	170	2424	1794	196	196	154.30	0.500	0.09	0.41	34.24
20/03/10	11	190	2366	1850	270	241	160.60	0.20	0.08	0.12	43.12
26/03/10	16	138	2624	2196	302	226	153.70	0.50	0.03	0.47	47.63
27/03/10	17	112	2348	2294	328	232	177.80	0.33	0.30	0.03	53.88
31/03/10	21	153	2856	2636	320	308	158.70	0.36	0.30	0.06	39.26
07/04/10	28	128	-	-	188	154	193.10	0.05	0.04	0.01	54.22
09/04/10	30	151			196	96	109.10	0.09	0.03	0.06	68.76
12/04/10	33	313	2580	1804	204	160	209.40	0.12	0.07	0.05	68.56
16/04/10	37	148	-	-	212	192	107.90	0.40	0.20	0.20	55.34
19/04/10	40	303	2982	2520		166	139.00	0.60	0.20	0.40	61.13
20/04/10	41	235	2395	2068	236	202	167.90	0.70	0.20	0.50	66.93
22/06/10	104	330	-	-	230	210	175.19	1.59	0.12	1.47	46.49
23/06/10	105	325	1442	1109	228	178	191.83	3.56	0.84	2.72	70.83
24/06/10	106	363	2548	1958	236	174	191.02	2.44	1.23	1.21	77.47
29/06/10	111	167	1582	1204	104	94	145.44	1.07	0.84	0.23	63.42
02/07/10	114	628	2640	1618	256	172	180.48	0.02	0.041	0.1	76.6
03/08/10	146	330	2230	1670	121	99	163.01	0.02	0.01	0.01	45.55
06/08/10	149	205	1754	1606	88	80	164.36	0	0	0	47.05
09/08/10	152	123	2514	1824	106	86	152.70	0	0.10	0	46.62
12/08/10	155	70	2530	2300	107	98	128.55	0.05	0.09	0	42.450
16/08/10	159	83	2554	2252	-	-	181.60	0	0.03	0.03	41.17
20/08/10	163	148	2486	2660	-	-	126.02	0	0.09	0.09	56.52
23/08/10	166	135	2766	1784	-	-	132.36	0.01	0.07	0.2	65.76

D 1.1.2 Effluent wastewater - Study 1 - Phase 1

Date	Day No.	SS mg/l	COD _t mg/l	COD _f mg/l	TN _t mg/l	TN _f mg/l	NH ₄ -N mg/l	TON mg/l	NO ₂ -N mg/l	NO ₃ -N mg/l	PO ₄ -P mg/l
18/03/10	8.1	13	142	20	52	46	19.6	27.60	2.75	24.85	21.76
19/03/10	9.6	50	245	82	54	52	28	24.55	2.60	21.95	29.55
20/03/10	10.6	32	186	24	75	68	16.7	12.92	1.65	11.25	26.85
25/03/10	15.1	78	276	60	78	72	16.8	10.15	2.40	7.75	39.72
26/03/10	16.1	54	256	112	102	90	19.6	9.81	3.55	6.25	42.7
01/04/10	22.1	54	151	46	97	87	16.39	18.23	7.70	10.53	35.35
07/04/10	28.4	122	-	-	104	48	20.06	41.42	12.58	28.84	58.41
12/04/10	33.4	150	-	-	88	26	2.64	33.71	9.32	24.39	57.26
18/04/10	39.2	168	166	58	72	22	19.05	10.95	4.75	6.22	57.11
19/04/10	40.3	116	-	-	76	15	2.89	21.71	6.82	14.89	43.94
25/04/10	46.1	147	156	62	68	18	3.39	24.57	3.80	20.77	44.03
30/04/10	51.1	187	-	-	37	19	1.13	7.21	1.05	6.16	43.78
02/07/10	114.3	427	394	103	63	33	0.25	5.12	0.48	4.64	22.69
28/07/10	140.1	228	296	19	68	46	0.01	9.35	0.01	9.34	16.05
30/07/10	141.7	157	-	-	-	-	0.13	8.88	0.02	8.86	18.36
03/08/10	146.1	165	104	9	38	23	1.31	4.24	0.27	3.98	29.68
04/08/10	147.1	250	509	34	55	23	0.98	9.05	2.17	6.88	14.49
05/08/10	148.1	348	350	32	38	19	1.32	8.59	0.76	7.83	12.47
06/08/10	149.1	292	289	24			3.37	7.42	1.25	6.17	12.73
09/08/10	152.4	200	266	29	31	19	2.96	4.27	0.05	4.22	10.30
10/08/10	153.1	320	253	22	32	14	1.10	5.77	0.19	5.58	9.80
10/08/10	153.3	224	338	22	40	19	3.29	1.25	0.16	1.08	8.82
11/08/10	154.1	260	307	14	-	-	0.61	3.18	0.11	3.08	10.75
11/08/10	154.3	263	364	297	35	13	1.29	1.57	0.14	1.43	10.98
12/08/10	155.1	378	536	12	-	-	0.66	3.60	0.18	3.42	9.93
12/08/10	155.3	315	297	21	29	14	0.05	0.49	0.21	0.28	10.70
13/08/10	156.0	453	528	18	54	15	2.25	5.37	0.27	5.11	11.04

D 1.1.2 Effluent wastewater - Study 1 - Phase 1 (cont'd)

Date	Day No.	SS mg/l	COD_t mg/l	COD_f mg/l	TN_t mg/l	TN_f mg/l	NH₄-N mg/l	TON mg/l	NO₂-N mg/l	NO₃-N mg/l	PO₄-P mg/l
16/08/10	159.0	515	502	24	-	-	1.01	5.81	0.37	5.44	11.11
16/08/10	159.4	575	719	30	56	18	0.64	5.52	0.20	5.32	12.35
17/08/10	160.0	545	110	89	-	-	2.07	3.52	0.16	3.35	10.54
18/08/10	161.0	550	106	102	62	17	4.05	5.01	0.53	4.49	10.50
19/08/10	162.0	490	-	-	-	-	1.746	1.371	0.549	0.822	11.72
20/08/10	163.0	462	-	-	-	-	1.23	2.99	0.41	2.58	13.52
23/08/10	166.0	475	-	-	-	-	0.99	3.01	0.51	2.50	12.67
24/08/10	167.0	468	-	-	-	-	1.02	2.99	0.69	2.30	10.15

D 1.1.3.1 Study 1 - Phase 1 - HSWIS 1

	min.	COD _f mg/l	TN _f mg/l	NH ₄ -N mg/l	TON mg/l	NO ₂ -N mg/l	NO ₃ -N mg/l	PO ₄ -P mg/l
Inf.	0	2022	250	185.19	0.00	0.08	0.00	151.23
90 min. anoxic period	1			151.96	16.65	2.94	13.71	44.06
	5	962	128	84.29	17.75	3.04	14.71	39.24
	10			41.62	17.55	2.98	14.57	38.80
	15	206	88	39.93	14.93	2.58	12.35	39.72
	20			38.04	13.34	2.33	11.01	39.86
	25	138	74	37.22	12.42	2.41	10.02	40.70
	30			36.49	11.13	1.92	9.22	40.49
	35			35.14	11.00	1.80	9.20	42.53
	40	104	68	34.75	8.95	1.38	7.58	46.03
	45			33.88	7.71	1.24	6.48	44.15
	50			33.47	6.83	1.00	5.84	45.32
	55			33.29	5.32	0.75	4.57	38.40
	60	71	64	32.63	4.10	0.59	3.52	47.69
	65			32.48	3.57	0.91	2.66	22.62
	70			31.79	2.04	0.04	2.00	22.97
	75			31.43	1.68	0.03	1.65	23.02
	80	59	58	31.26	1.47	0.03	1.45	36.01
85			31.13	1.14	0.02	1.12	23.42	
90	51	58	31.58	0.96	0.04	0.92	24.09	
585 min. aerobic period	100			31.82	1.14	0.03	1.12	23.72
	105	42	58	32.49	1.56	0.03	1.53	25.80
	125			32.09	1.83	0.03	1.81	25.95
	145			32.97	2.13	0.03	2.10	28.22
	165			31.54	2.04	0.02	2.02	29.24
	185	41	64	31.47	2.43	0.03	2.40	26.74
	205			31.58	2.94	0.24	2.70	26.55
	225			30.69	3.50	0.47	3.03	28.38
	245			30.04	3.67	0.41	3.26	28.24
	265	36	59	29.20	3.88	0.37	3.51	25.21
	285			28.48	3.94	0.64	3.30	21.00
	305			27.97	4.15	0.73	3.42	23.22
	325			28.57	4.70	1.10	3.60	30.96
	345	36	54	28.33	5.25	1.20	4.05	30.42
	365			27.80	5.62	1.90	3.72	30.91
	385			27.18	7.85	2.23	5.62	34.80
	405			26.15	10.30	2.85	7.45	32.80
	425	36	48	24.13	10.29	4.11	6.17	32.68
	465			24.29	10.72	4.38	6.34	33.53
	485			23.10	11.28	4.96	6.32	41.99
	505			21.67	12.60	4.89	7.71	43.04
	525	34	45	21.34	13.72	5.11	8.62	40.05
545			21.04	14.02	5.27	8.74	48.42	
565			19.65	15.62	5.94	9.68	44.89	
585			17.54	16.65	6.45	10.19	47.87	
605	32	38	15.32	18.91	7.33	11.58	50.57	
625			14.68	20.17	8.60	11.57	52.88	
645			13.18	21.71	9.29	12.43	46.23	
665			11.22	22.34	10.65	11.69	46.51	
670	28	31.5	9.75	22.77	10.16	12.60	55.86	

D 1.1.3.1 Study 1 - Phase 1 - HSWIS 1 (cont'd)

	min.	COD_f mg/l	TN_f mg/l	NH₄-N mg/l	TON mg/l	NO₂-N mg/l	NO₃-N mg/l	PO₄-P mg/l
S	680			9.14	22.96	11.06	11.90	56.22
	690	20	31	8.77	22.75	11.15	11.60	57.94
	700			8.23	23.13	11.25	11.88	56.41
	710	28	37	8.06	22.52	10.94	11.58	55.55
	720			8.08	22.19	10.78	11.41	56.95
Eff.	725	21	37	8.19	22.53	10.86	11.66	57.30

S – 45 minute settlement period

D 1.1.3.2 Phase 1 – Study 1 - HSWIS 1

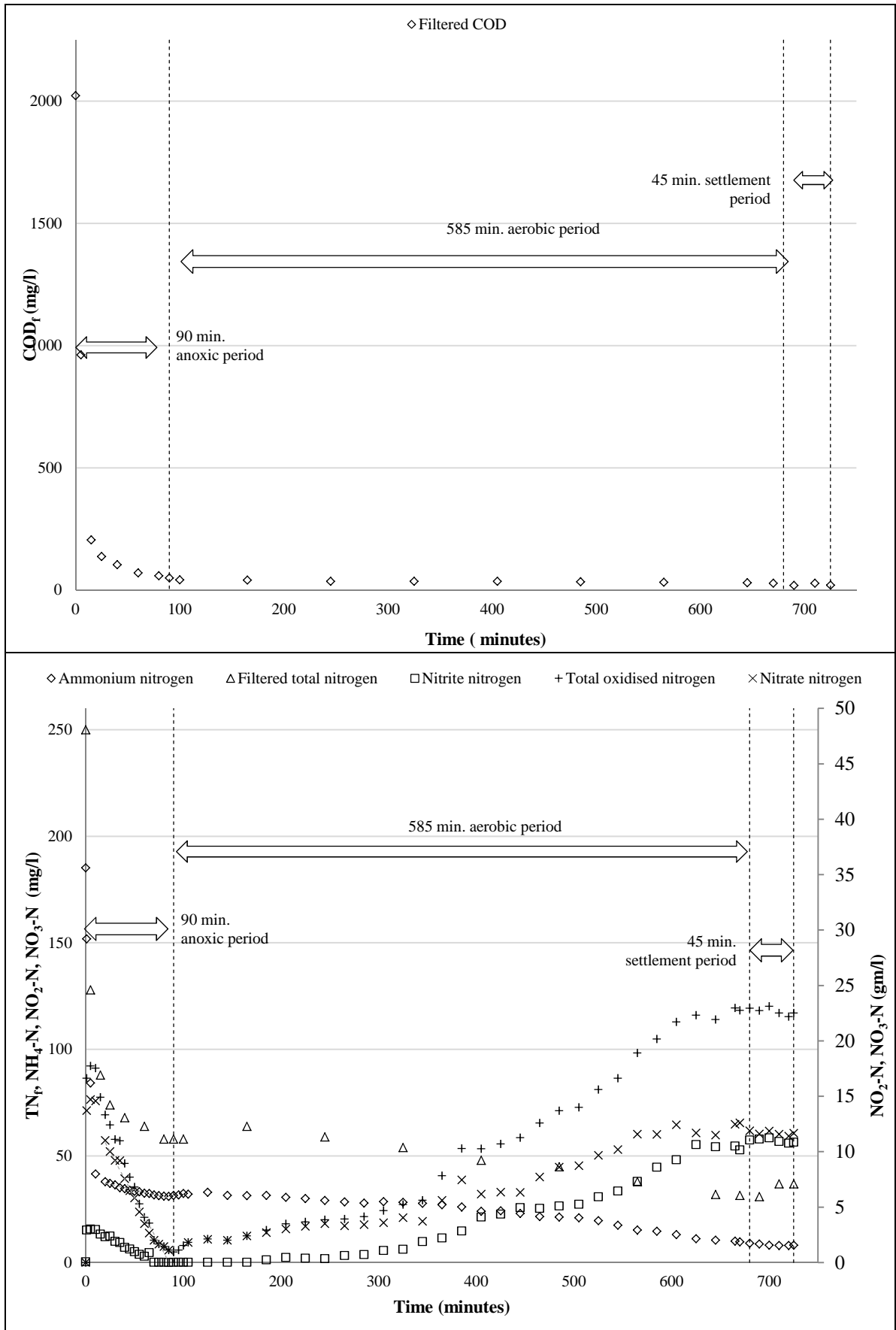

D 1.1.3.2 Study 1- Phase 1 – HSWIS 1 (cont'd)

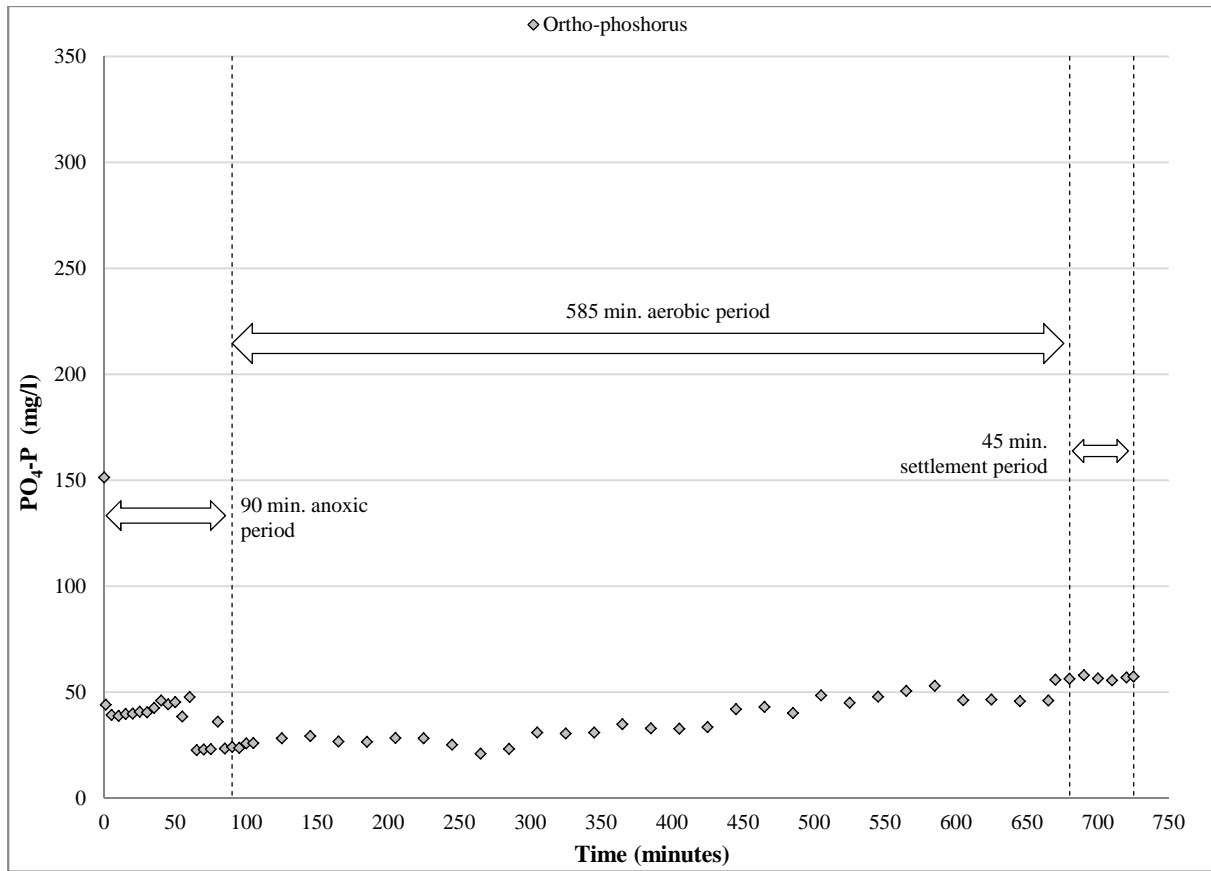

D 1.1.4.1 Study 1 - Phase 1 - HSWIS 2

	min.	COD _f mg/l	TN _f mg/l	NH ₄ -N mg/l	TON mg/l	NO ₂ -N mg/l	NO ₃ -N mg/l	PO ₄ -P mg/l
90 min. anoxic period	0	1908	278	210.52	0.20	0.19	0.00	87.73
	1			129.36	8.47	3.60	4.87	83.72
	5	1089	136	86.34	9.95	8.03	1.92	25.90
	10	680	62	51.25	14.45	6.91	7.55	25.00
	15	448	56	42.61	14.64	6.69	7.95	27.47
	20	251	50	37.04	11.62	6.73	4.89	28.37
	25			36.72	10.44	4.33	6.11	29.55
	30	135	58	36.20	10.35	4.45	5.90	32.19
	35			35.91	9.28	3.95	5.33	31.72
	40	117	56	35.59	7.92	3.49	4.43	33.83
	45			35.09	6.23	3.02	3.21	34.12
	50			34.78	5.46	2.84	2.62	35.65
	55			34.28	5.60	2.93	2.67	40.50
	60	102	48	33.91	4.46	2.41	2.05	52.42
	65			33.34	3.89	3.28	0.61	37.03
	70			33.02	2.43	1.43	1.00	38.80
	75			32.97	1.85	0.46	1.39	39.43
	80	94	61	33.08	0.80	0.67	0.13	42.27
	85			32.94	0.17	0.05	0.12	46.48
	90	78.5	60	32.74	0.21	0.03	0.18	49.32
95			32.48	0.17	0.06	0.11	46.62	
100	63	59	32.09	0.16	0.06	0.10	47.50	
105			32.39	0.18	0.05	0.13	50.24	
125			32.30	0.07	0.13	0.00	49.04	
145			32.60	0.22	0.36	0.00	52.76	
165	36	57	32.44	0.51	0.57	0.00	60.55	
185			32.38	0.95	0.87	0.08	37.31	
205			32.17	1.65	1.31	0.34	36.71	
225			31.65	2.50	1.78	0.72	36.90	
245	36	50	31.62	3.26	2.12	1.13	34.72	
265			31.17	4.05	2.52	1.52	33.96	
285			31.14	4.99	2.90	2.09	37.11	
305			28.16	5.97	3.34	2.63	30.05	
325	28	46	26.70	7.17	3.88	3.29	28.53	
345			25.75	8.25	4.36	3.90	28.50	
365			24.36	9.37	4.84	4.53	28.00	
385			22.90	10.97	5.42	5.55	28.28	
405	40	40	22.73	12.72	6.00	6.72	30.84	
425			22.54	11.70	5.94	5.76	18.52	
445			20.61	13.33	6.25	7.08	19.10	
465			19.86	13.98	6.26	7.72	18.33	
485	37	38	17.87	14.19	6.22	7.97	17.23	
505			17.33	14.54	6.37	8.18	16.81	
525			16.24	14.90	6.77	8.13	15.89	
545			15.49	15.77	7.21	8.56	15.58	
565	41	36	14.10	16.09	7.83	8.26	14.64	
585			14.17	16.17	8.59	7.58	15.13	
605			11.97	16.36	8.80	7.55	14.87	
585 min. aerobic period								

D 1.1.4.1 Study 1 - Phase 1 - HSWIS 2 (cont'd)

	min.	COD_f mg/l	TN_f mg/l	NH₄-N mg/l	TON mg/l	NO₂-N mg/l	NO₃-N mg/l	PO₄-P mg/l
A	625	46	42	11.60	18.15	10.08	8.06	15.43
	645			10.38	17.80	10.58	7.22	13.78
	665			10.21	19.03	11.19	7.84	13.85
	670	48	38	10.10	19.22	11.48	7.74	13.91
S	680	51	34	9.59	19.34	11.42	7.92	13.40
	690			9.72	19.78	11.27	8.51	13.50
	700	49	37	10.05	20.97	11.78	9.20	15.31
	710			7.61	14.30	8.82	5.48	10.53
	720	51	34	10.98	23.54	13.27	10.27	15.77
Eff.	725	46	42	11.29	20.51	11.66	8.84	14.98

A – Aerobic period cont'd; S – 45 min. settlement period

D 1.1.4.2 Study 1 - Phase 2 – HSWIS 2

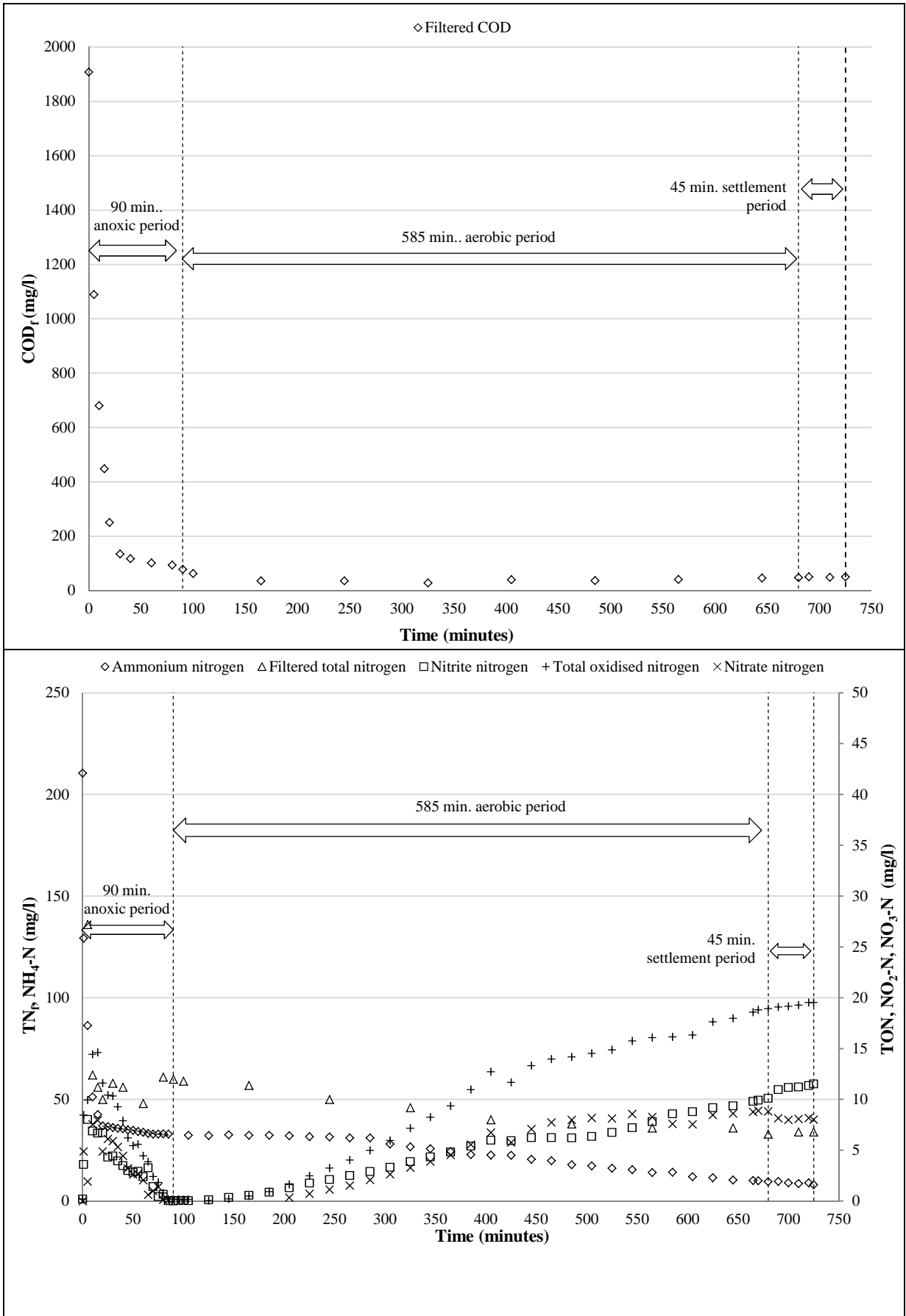

D 1.1.4.2 Study 1- Phase 2 –HSWIS 2 (cont'd)

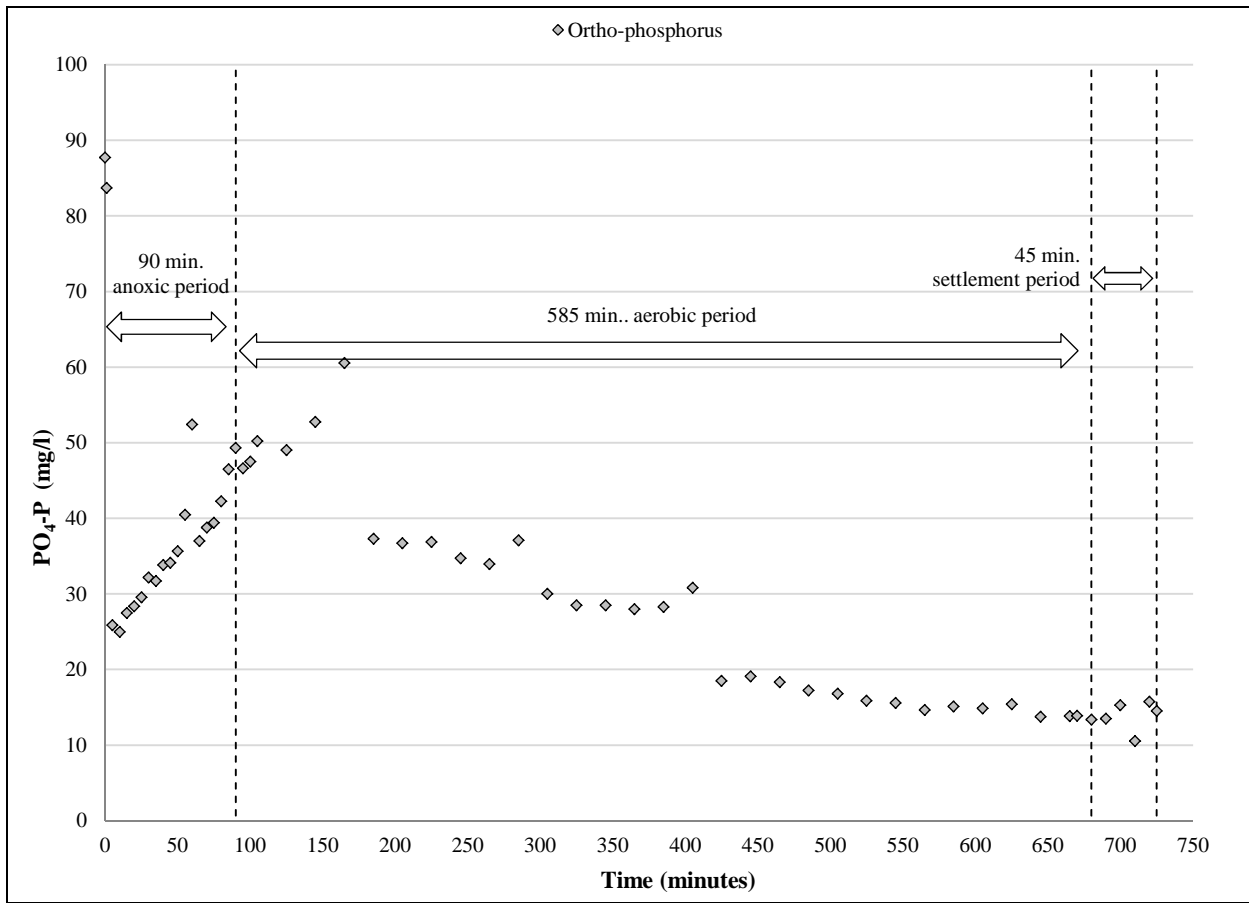

D.1.1.5.1 Study 1 - Phase 1 - HSWIS 3

	min.	COD _f mg/l	TN _f mg/l	NH ₄ -N mg/l	TON mg/l	NO ₂ -N mg/l	NO ₃ -N mg/l	PO ₄ -P mg/l	
90 min. anoxic period	Inf.	0	1024	194	169.96	1.80	0.06	1.74	32.21
	1				73.67	10.23	0.35	9.88	30.01
	5		353	92	31.16	13.13	9.75	3.38	
	10		298	74	29.80	18.57	10.59	7.99	
	15		355	58	28.12	21.39	13.87	7.52	26.45
	20		189	56	26.42	19.03	13.56	5.48	
	25				25.96	17.44	13.45	3.99	
	30				25.85	16.04	12.48	3.56	26.57
	35				25.78	15.85	11.90	3.95	
	40		185	48	25.42	13.57	10.32	3.26	
	45				25.22	12.24	9.15	3.09	26.95
	50				25.16	11.76	8.82	2.94	
	55				24.86	10.13	7.32	2.82	
	60		157	38	24.44	9.86	7.58	2.28	27.70
	65				24.13	8.48	6.64	1.84	
	70				23.96	7.35	5.51	1.84	
	75				23.41	6.31	4.87	1.44	
	80		88	34	23.32	5.13	3.57	1.57	
	85				23.15	4.52	2.91	1.62	28.29
	90		64	35	24.50	4.71	0.30	4.41	
585 min. aerobic period	95			24.76	5.70	0.17	5.52		
	100		40	36	24.59	6.25	0.05	6.20	30.13
	105				23.16	6.42	0.04	6.37	
	125				22.86	4.74	0.34	4.40	
	145				22.82	5.34	0.76	4.58	32.85
	165		37	36	21.86	6.46	1.28	5.18	
	185				19.53	7.29	1.84	5.45	
	205				18.91	8.50	2.40	6.09	32.68
	225				17.89	9.95	3.09	6.86	
	245		40	34	17.47	11.61	3.74	7.87	
	265				16.83	12.25	4.44	7.82	32.73
	285				15.94	13.19	4.55	8.64	
	305				15.17	13.87	5.08	8.79	
	325		45	32	13.19	14.58	5.71	8.87	32.67
	345				12.69	15.28	6.13	9.15	
	365				12.30	15.86	6.65	9.22	
	385				12.04	16.30	6.90	9.39	32.53
	405		45	35	11.19	16.84	7.16	9.67	
	425				10.53	17.13	7.89	9.24	
	445				9.46	17.51	7.92	9.59	32.39
465				8.99	17.99	8.29	9.70		
485		46	32	8.85	18.20	8.55	9.65		
505				8.87	18.54	8.68	9.87	32.96	
525				8.81	19.81	8.93	10.88		
545				7.96	20.05	9.08	10.97		
565		47	29	8.14	20.70	9.32	11.37	32.65	
585				7.91	21.15	9.47	11.68		
605				7.75	21.83	9.64	12.19		
625				7.68	22.19	9.77	12.42	32.57	
645		42	24	7.70	22.83	10.03	12.79		
665				7.71	23.15	10.28	12.87		

D 1.1.5.1 Study 1 - Phase 1 - HSWIS 3 (cont'd)

	min.	COD_f mg/l	TN_f mg/l	NH₄-N mg/l	TON mg/l	NO₂-N mg/l	NO₃-N mg/l	PO₄-P mg/l
A	670			7.66	23.90	10.49	13.41	32.75
	680			7.68	24.14	10.50	13.65	
S	690	43	22	7.64	24.89	11.18	13.70	
	700			7.13	25.20	11.79	13.42	32.90
	710	37		6.97	25.87	12.07	13.79	
	720			6.94	26.19	11.97	14.22	
Eff.	725	34	20	6.51	26.51	12.66	13.85	32.93

A -Aerobic period continued; S - 45 minute settlement period

D 1.1.5.2 Study 1 – Phase 1 - HSWIS 3

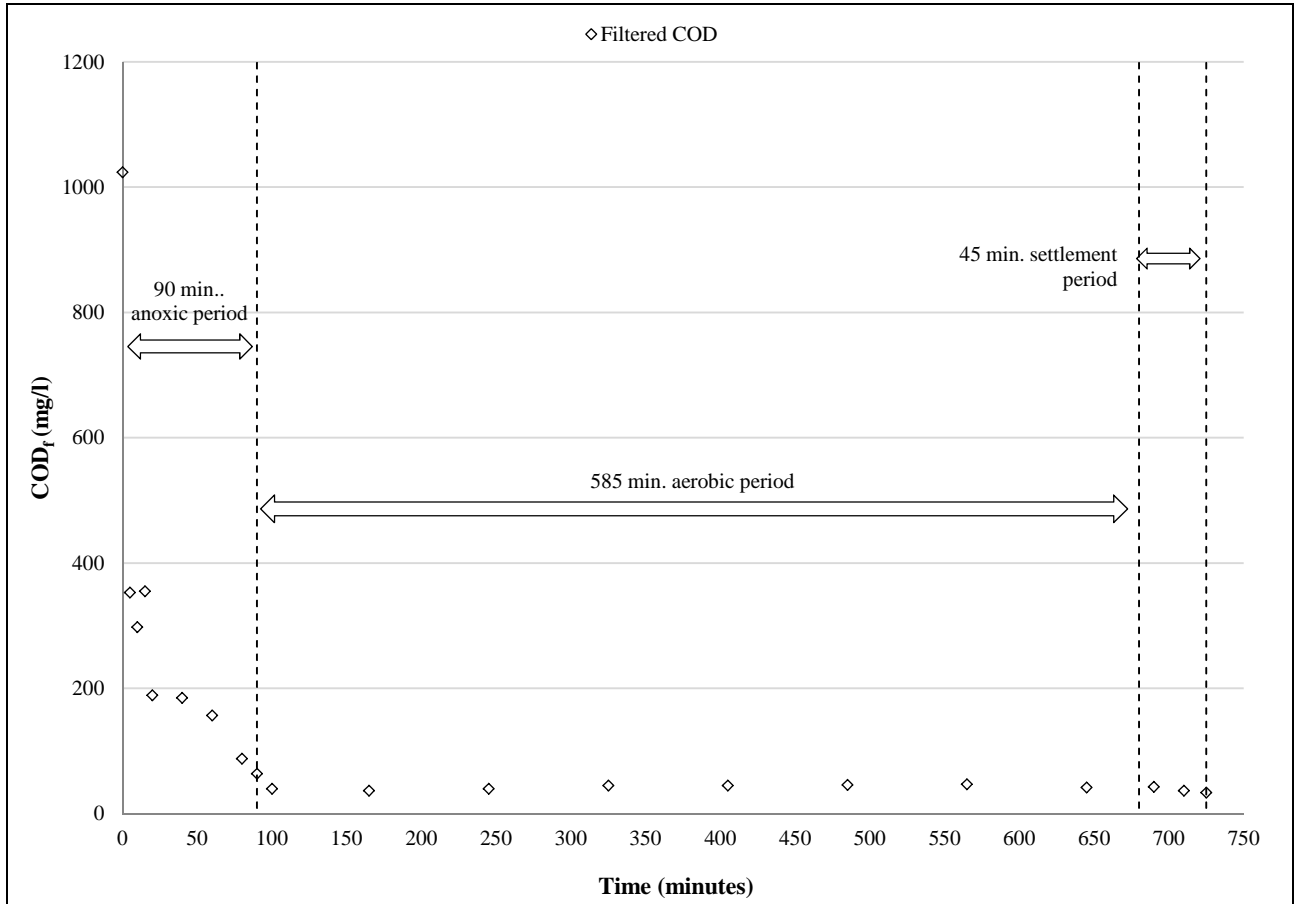

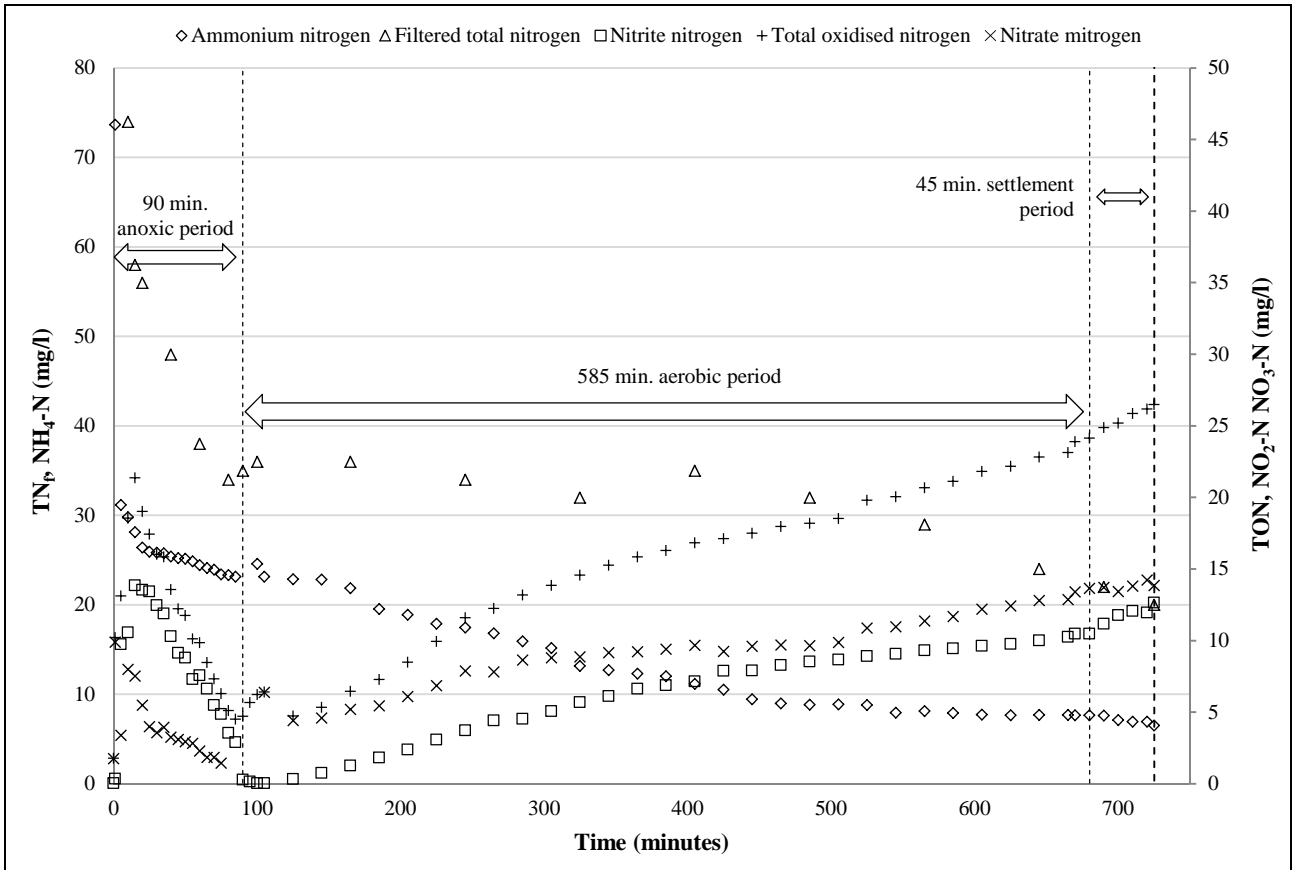

D 1.1.5.2 Study 1 – Phase 1 - HSWIS 3 (cont'd)

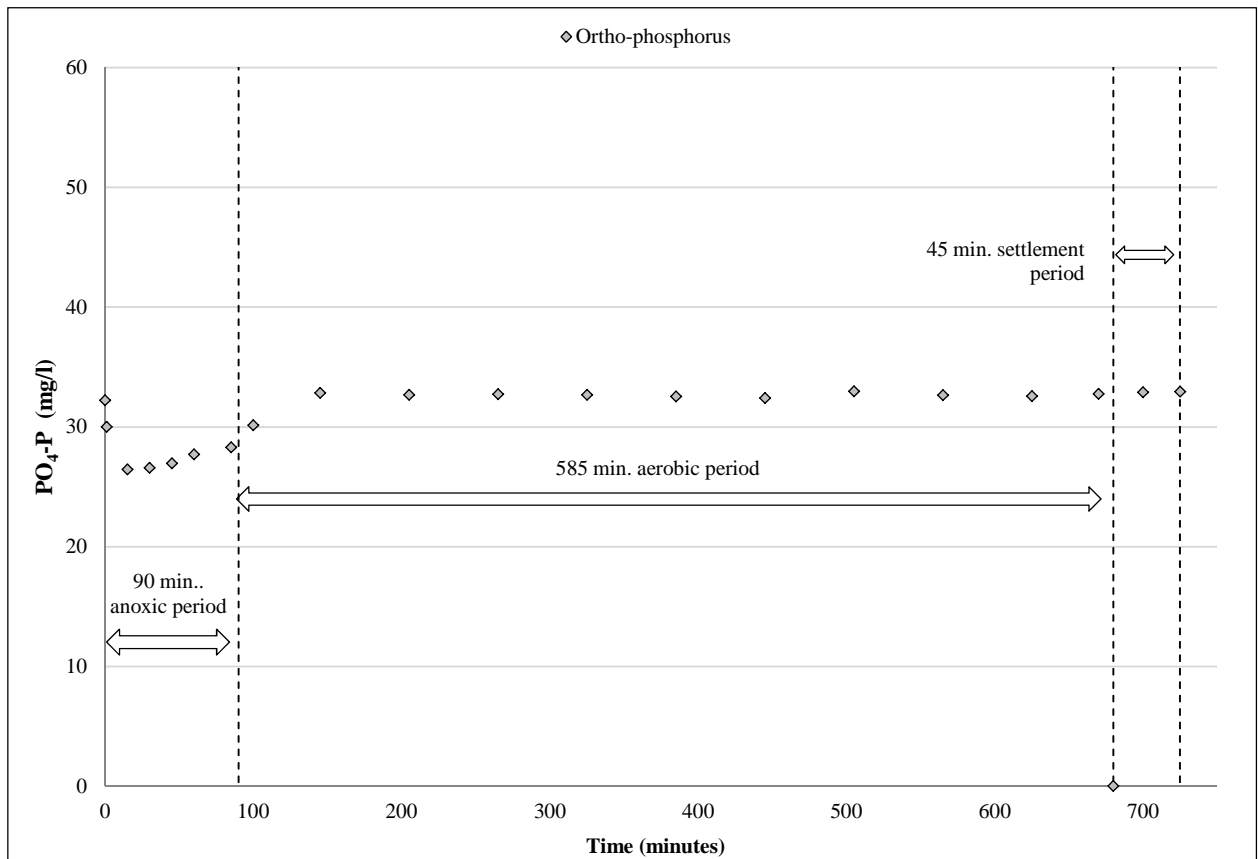

D 1.2.1 Influent wastewater Study 1 – Phase 2 cont'd

Date	Day No.	SS mg/l	COD mg/l	COD_f mg/l	TN mg/l	TN_f mg/l	NH₄-N mg/l	TON mg/l	NO₂-N mg/l	NO₃-N mg/l	PO₄-P mg/l
08/11/10	62.4	290	2642	2082	180	172	120.84	0	0.13	0	55.63
10/11/10	64.0	256	2510	2168	182	156	114.22	0.008	0.14	0	43.75
12/11/10	66.3	400	2374	1774	-	-	202.09	0	0.16	0	40.31
15/11/10	69.0	260	2398	1988	254	162	227.09	0	0.11	0	53.61
16/11/10	70.3	223	2440	2190	-	-	230.82	0	0.12	0	49.60
19/11/10	73.0	223	-	-	-	-	240.98	0	0.11	0	50.72
22/11/10	76.0	285	2758	2518	298	296	156.49	0	0.06	0	50.476
23/11/10	77.0	300	1794	2398	288	279	162.96	0	0.07	0	65.36
24/11/10	78.0	190	2382	1934	224	218	132.15	0	0.17	0	50.21
25/11/10	79.3	293	2542	1944	222	186	231.43	0	0.43	0	48.52
26/11/10	80.3	230	2272	1774	-	-	173.73	0	0.2	0	43.62
29/11/10	83.1	193	-	-	-	-	235.14	0	0.14	0	56.86
29/11/10	83.2	200	2530	2020	-	-	164.67	0	0.23	0	58.01
04/12/10	88.3	317	-	-	224	204	173.98	0	0.15	0	37.32
07/12/10	91.1	343	-	-	192	170	161.33	0	0.17	0	33.84
09/12/10	93.0	290	2376	1904	256	216	164.20	0	0.14	0	39.31
10/12/10	94.1	300	-	-	-	-	184.78	0	0.16	0	41.28
13/12/10	97.0	273	2596	2298	200	192	173.54	0	0.22	0	33.03
14/12/10	98.5	303	-	-	-	-	190.24	0	0.10	0	64.41
16/12/10	100.0	360	-	-	-	-	189.34	0	0.12	0	63.68
17/12/10	101.0	383	-	-	-	-	196.43	0	0.32	0	41.44
20/12/10	104.2	377	-	-	182	168	206.16	0	0.08	0	67.15
28/12/10	112.2	260	-	-	-	-	211.14	0	0.13	0	48.58
10/01/11	125.0	350	2584	1988	174	154	179.37	0	0.14	0	32.65
13/01/11	128.2	290	-	-	111	63	182.89	0	0.14	0	42.53
14/01/11	129.2	255	-	-	-	-	157.22	0	0.15	0	41.18

D 1.2.1 Influent wastewater - Study 1 – Phase 2 (cont'd)

Date	Day No.	SS mg/l	COD mg/l	COD_f mg/l	TN mg/l	TN_f mg/l	NH₄-N mg/l	TON mg/l	N₀₂-N mg/l	NO₃-N mg/l	PO₄-P mg/l
25/01/11	140.3	256	2510	2168	182	156	114.22	0`	0.14	0	43.75
27/01/11	142.0	400	2374	1774	-	-	202.09	0	0.16	0	40.31
28/01/11	143.0	373	-	-	-	-	193.63	0	0.07	0	37.76
31/01/11	146.0	227	2556	2242	284	242	193.28	0	0.10	0	49.07
03/02/11	149.2	267					195.32	0	0.18	0	82.35
07/02/11	153.2	252					107.7	0	0.14	0	51.31
09/02/11	155.1	147	2636	2264	256	216	211.27	0	0.2	0	55.54
14/02/11	160.1	280	2806	2522	244	232	102.35	0	0.14	0	44.50
17/02/11	163.0	290	-	-	-	-	138.49	0	0.17	0	68.15
18/02/11	164.1	300	-	-	-	-	123.07	0	0.14	0	71.19
21/02/11	167.1	140	-	-	-	-	155.61	0.1	0.27	0	69.12
21/02/11	167.3	245	-	-	-	-	118.18	0	0.98	0	60.24
04/03/11	178.1	305	2544	1386	-	-	116.38	0	0.16	0	47.41
07/03/11	181.3	300	2840	1454	-	-	113.89	0.1	0.28	0	52.68
11/03/11	185.0	265	-	-	-	-	191.40	0	0.04	0	51.37
15/03/11	189.0	255	-	-	-	-	168.49	0	0.10	0	54.28
25/03/11	199.0	238	-	-	-	-	189.98	0	0.02	0	52.56
28/03/11	202.0	220	2798	2430	304	252	156.76	0	0.18	0	39.69
31/03/11	205.0	185	2504	1938	-	-	166.42	0	0.11	0	45.99
05/04/11	210.0	295	2710	2064	-	-	179.02	0	0.07	0	50.73
07/04/11	212.1	250	-	-	-	-	194.27	0	0.17	0	56.84
10/05/11	245.1	275	2520	1648	274	256	139.47	0	0.14	0	39.36
13/05/11	248.0	225	2696	2234	286	230	119.04	0	0.23	0	34.86
17/05/11	252.0	220	2686	2176	320	206	118.14	0	0.01	0	41.91
20/05/11	255.0	218	-	-	-	-	132.13	0	0.02	0	43.23
29/05/11	264.0	216	2580	2086	272	226	131.51	0.01	0.02	0	46.34

D 1.2.2 Effluent wastewater - Study 1 – Phase 2

Date	Day No.	SS mg/l	COD mg/l	COD_f mg/l	TN mg/l	TN_f mg/l	NH₄-N mg/l	TON mg/l	NO₂-N mg/l	NO₃-N mg/l	PO₄-P mg/l
08/11/10	62.4	367	840	67	-	-	0.52	8.27	0.23	8.04	4.46
10/11/10	63.9	1100	825	45	57	20	8.993	8.57	1.10	7.48	11.25
11/11/10	65.3	980	1097	34	93	17	8.56	4.12	0.14	3.99	2.44
12/11/10	65.9	1313	1637	51	-	-	5.21	8.03	1.99	6.04	4.66
23/11/10	77.2	900	837	33	61	35	19.89	11.38	3.31	8.07	3.25
24/11/10	77.9	977	-	-	-	-	23.82	0.55	0.21	0.34	3.66
24/11/10	78.3	1450	1281	25	104	26	10.11	8.33	1.98	6.35	4.41
25/11/10	78.9	1510	1146	83	88	32	9.65	8.58	0.20	8.38	3.65
25/11/10	79.3	983	890	19	-	-	15.26	3.92	0.58	3.34	7.34
26/11/10	79.9	1127	-	-	50	24	11.65	15.04	2.50	12.54	2.79
09/12/10	93.0	1007	1107	107	-	-	0.76	7.45	0.05	7.40	1.77
21/12/10	105.0	1423	1526	33	98	14	3.63	9.08	0.43	8.65	2.73
21/12/10	105.5	1685	1418	26	-	-	0.87	7.09	0.09	7.00	2.43
22/12/10	106.2	700	1426	30	146	25	1.31	5.41	0.02	5.39	7.81
11/01/11	126.0	1780	920	67	84	20	11.37	18.6	0.59	8.01	2.23
11/01/11	126.2	1695	1218	70	89	21	4.22	10.23	1.67	8.56	1.21
12/01/11	127.0	2005	1189	136	176	14	3.45	7.75	0.36	7.39	1.36
14/01/11	129.0	1480	-	-	103	35	50.76	1.24	0.49	7.75	14.02
14/01/11	129.2	760	-	-	52	33	35.09	4.96	1.70	3.26	13.63
20/01/11	134.9	360	547	161	-	-	87.18	9.99	4.46	5.53	28.22
20/01/11	135.1	385	588	140	76	51	67.42	21.95	9.82	12.13	18.38
25/01/11	139.9	247	260	51	41	21	1.05	5.48	0.42	5.06	2.59
26/01/11	140.9	260	330	57	28	15	1.19	15.97	0.82	15.15	6.09
26/01/11	141.3	395	-	-	-	-	0.30	13.64	0.3	13.34	6.45
27/01/11	141.9	267	375	50	54	26	0.23	8.57	0.46	8.11	8.20
28/01/11	142.9	240	208	38	38	21	0.26	9.05	0.5	8.55	17.43

D 1.2.2 Effluent wastewater - Study 1 – Phase 2 (cont'd)

Date	Day No.	SS mg/l	COD mg/l	COD_f mg/l	TN mg/l	TN_f mg/l	NH₄-N mg/l	TON mg/l	NO₂-N mg/l	NO₃-N mg/l	PO₄-P mg/l
01/02/11	146.9	280	309	74	51	38	1.61	17.51	1.61	15.9	23.76
01/02/11	146.9	283	-	42	53	25	1.78	13.06	1.46	11.6	23.69
01/02/11	147.5	260	267	65	42	30	0.05	9.16	0.71	8.45	22.55
02/02/11	148.0	157	-	-	45	23	0.36	7.45	0.45	7	28.84
03/02/11	148.9	150	-	-	76	42	0.56	7.17	0.86	6.31	32.76
03/02/11	149.0	149	--	-	76	42	17.43	3.45	1.22	2.23	55.64
08/02/11	154.2	363	537	141	54	20	1.71	11.95	3.73	8.22	7.82
09/02/11	155.3	325	592	144	-	-	19.88	8.29	2.77	5.52	26.70
10/02/11	155.9	370	470	88	-	--	6.03	7.98	2.75	5.23	8.28
10/02/11	156.3	395	715	149	-	-	2.13	10.26	10.26	0	2.58
11/02/11	156.9	435	-	-	-	-	0.52	2.56	0.60	1.96	2.58
14/02/11	160.1	325	-	-	-	-	0.35	7.34	0.31	7.02	6.07
15/02/11	161.0	455	624	128	74	9	0.59	7.48	0.45	7.03	5.89
15/02/11	161.2	480	-	-	-	-	0.51	15.14	1.79	13.35	6.83
16/02/11	161.9	425	-	-	-	-	0.31	9.48	0.44	9.04	6.72
16/02/11	162.2	430	-	-	-	-	0.31	8.02	0.41	7.61	8.39
17/02/11	162.9	550	-	-	-	-	0.19	8.32	0.30	8.02	7.95
17/02/11	163.2	610	742	68	-	-	7.09	16.78	1.15	15.63	19.33
18/02/11	164.0	465	-	-	-	-	0	9.49	0.53	8.96	20.40
02/03/11	175.7	370	-	-	-	-	0	15.93	0.28	15.65	5.97
03/03/11	177.5	445	709	45	70	22	0.75	8.40	0.21	8.19	7.41
07/03/11	180.9	595	792	50	55	21	1.03	8.39	0.35	8.05	21.33
09/03/11	183.3	785	862	50	-	-	0.27	8.77	0.13	8.64	19.00
10/03/11	184.0	C	-	-	-	-	3.02	6.11	0.36	5.75	20.59
23/03/11	196.9	750	840	71	44	104	1.22	14.34	0.41	13.93	29.49
23/03/11	197.0	C	783	56	-	-	0.34	16.11	0.39	15.72	43.3

D 1.2.2 Effluent wastewater - Study 1 – Phase 2 (cont'd)

Date	Day No.	SS mg/l	COD mg/l	COD _f mg/l	TN mg/l	TN _f mg/l	NH ₄ -N mg/l	TON mg/l	NO ₂ -N mg/l	NO ₃ -N mg/l	PO ₄ -P mg/l
24/03/11	198.0	C	-	-	-	-	1.04	25.05	0.19	24.86	39.55
24/03/11	198.2	945	-	-	-	-	0.52	16.65	0.18	16.47	35.10
25/03/11	198.9	C	-	-	-	-	1.46	9.44	0.20	9.24	38.81
29/03/11	203.0	757	800	34	-	-	0.4	8.71	0.15	8.56	25.75
29/03/11	203.3	725	-	-	-	-	0.8	8.23	0.25	7.98	27.34
30/03/11	204.1	505	532	41	52	9	0.26	3.48	0.32	3.16	29.34
01/04/11	206.0	915	-	-	-	-	0.43	1.36	0.15	1.21	8.3
01/04/11	206.1	395*	500	59	16	45	0.37	2.23	0.09	2.14	9.86
07/04/11	212.1	260	379	63	-	-	0.8	4.61	0.11	4.5	6.25
12/04/11	217.0	690	-	-	-	-	0.71	12.74	0.28	12.46	3.52
12/04/11	217.2	670	622	44	51	25	0.52	12.25	0.24	12.01	3.22
15/04/11	219.9	690	-	-	-	-	0.95	6.36	0.29	6.07	2.75
15/04/11	220.0	530	721	44	60	11	1.28	8.58	0.19	8.39	0.68
11/05/11	245.9	575	693	35	93	70	2.4	16.502	0.10	16.41	7.80
11/05/11	246.2	620	-	-	-	-	1.44	21.72	5.57	26.15	9.13
12/05/11	247.0	595	-	-	-	-	2.68	27.07	5.97	21.10	9.09
12/05/11	247.2	645	580	41	76	32	1.51	29.09	4.23	24.86	7.11
13/05/11	248.0	640	-	-	-	-	1.51	15.66	2.38	13.29	8.93
18/05/11	253.0	780	808	51	81	7	0.3	5.99	1.52	4.47	3.51
18/05/11	253.2	665	-	-	-	-	0.31	7.62	2.57	5.03	3.26
19/05/11	253.9	600	587	29	63	19	0.23	9.65	4.09	5.56	2.83
19/05/11	254.2	665	-	-	-	-	1.21	8.11	4.53	3.58	2.83
20/05/11	255.0	615	649	33	66	16	0.81	8.58	0.28	8.3	6.61
24/05/11	259.0	535	-	-	-	-	1.12	8.71	0.25	8.46	9.65
24/05/11	259.2	515	-	-	-	-	1.04	12.65	0.28	12.37	7.85

C – Sample centrifuged

D 1.2.3.1 Study 1 - Phase 2 – HSWIS 4

	min.	COD _f mg/l	TN _f mg/l	NH ₄ -N mg/l	TON mg/l	NO ₂ -N mg/l	NO ₃ -N mg/l	PO ₄ -P mg/l
90 min. anoxic period	Inf.	1636	92	184.85	0	0.11	0.001	67
	5			93.57	6.52	0.25	6.27	8.9
	10		18	60.33	7.35	0.16	7.19	4.4
	15			57.43	7.42	0.16	7.26	4.1
	20	70	35	55.68	7.39	0.26	7.13	3.8
	25			54.15	6.74	0.16	6.58	6.1
	30			53.66	6.35	0.15	6.2	4.2
	35		33	50.72	5.22	0.13	5.09	9.1
	40	164		49.38	4.83	0.15	4.68	17
	45			48.74	4.69	0.17	4.52	5.8
	50		36	47.92	4.52	0.15	4.37	17
	55			46.93	4	0.12	3.88	18
	60	146		46.38	3.46	0.13	3.33	15
	65			45.93	3.81	0.21	3.6	15
	70			45.28	3.59	0.14	3.45	15
	75			45.00	3.37	0.15	3.22	14
	80	148		44.73	2.82	0.17	2.65	17
	85			44.26	2.51	0.19	2.32	11
	90		35	44.32	2.41	0.12	2.29	18
598 min. aerobic period	95	92	46	44.28	2.06	0.16	1.9	23
	105		35	44.35	1.26	0.25	1.01	25
	125			28.96	1.08	0.43	0.65	27
	145		26	29.11	1.42	0.51	0.91	21
	165	64		27.94	2.45	0.6	1.85	14
	185			26.66	3.46	0.77	2.69	12
	205			23.18	3.83	0.52	3.31	7.6
	225			20.32	3.71	0.71	3.00	6.1
	245	64	15	17.71	4.35	1.27	3.08	3.9
	265			15.05	6.39	1.65	4.74	1.9
	285			15.07	8.24	2.11	6.13	1.2
	305			13.39	10.84	2.11	8.73	1.1
	325	24	27	10.48	12.64	2.41	10.23	1.1
	345			8.17	14.42	2.71	11.71	1
	365			6.23	16.51	3.03	13.48	0.9
	385			4.37	18.00	3.28	14.72	0.8
	405			2.95	20.23	3.35	16.88	0.9
	425	47		2.11	21.15	3.2	17.95	0.9
	445			1.58	22.25	2.85	19.40	1.1
	465			1.42	22.55	2.25	20.30	0.7
485		19	1.55	23.11	1.52	21.59	0.7	
505			1.55	23.60	1	22.60	1	
525	29		1.26	24.01	0.62	23.39	0.7	
545			1.17	23.85	0.2	23.65	0.5	
565			0.94	23.74	0.14	23.60	0.6	
585			1.06	23.92	0.11	23.81	0.5	

D 1.2.3.1 Study 1 - Phase 2 - HSWIS 4 (cont'd)

	min.	COD_f mg/l	TN_f mg/l	NH₄-N mg/l	TON mg/l	NO₂-N mg/l	NO₃-N mg/l	PO₄-P mg/l
A	605	72		0.94	23.80	0.1	23.70	0.4
	625			0.88	23.90	0.1	23.80	0.3
	645			0.86	23.90	0.09	23.81	0.3
	665	50		0.86	24.08	0.09	23.99	0.3
	685			0.90	24.01	0.09	23.92	0.3
S	705			0.86	23.98	0.08	23.90	0.2
	710			0.83	23.94	0.08	23.86	0.3
	715			0.85	23.83	0.08	23.75	0.2
	720	46		0.90	23.85	0.08	23.77	0.2
	725			0.65	23.96	0.08	23.88	0.2
	730			0.88	23.92	0.08	23.84	0.2
	735		8	1.10	23.83	0.08	23.75	0.2
Eff.	737	86	44	0.88	23.96	0.08	23.88	0.2

A – Aerobic period continued; S - 45 min. settlement period

D 1.2.3.2 Study 2 – Phase 2 – HSWIS 4

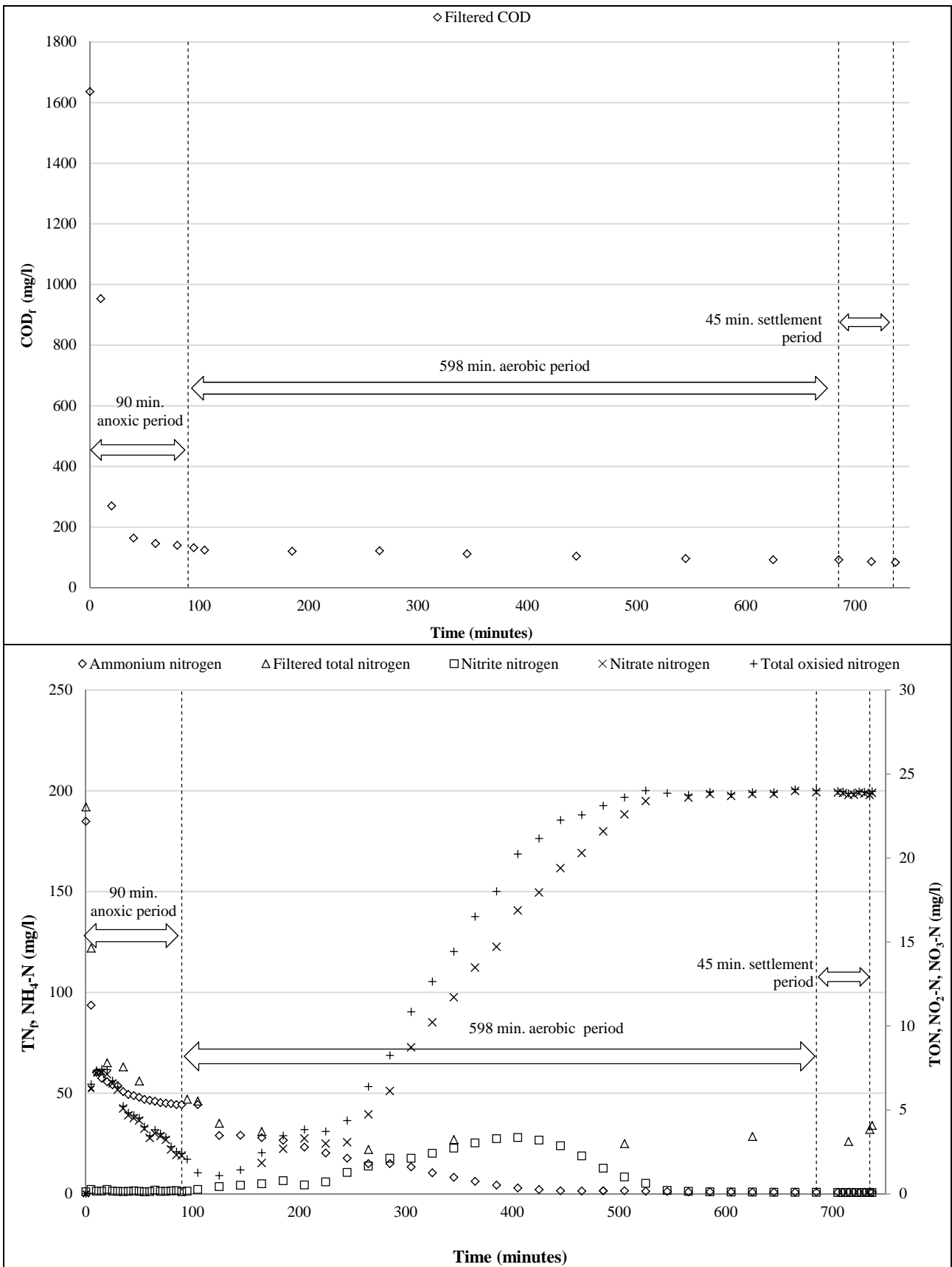

D 1.2.3.2 Study 2 – Phase 2 – HSWIS 4 (cont'd)

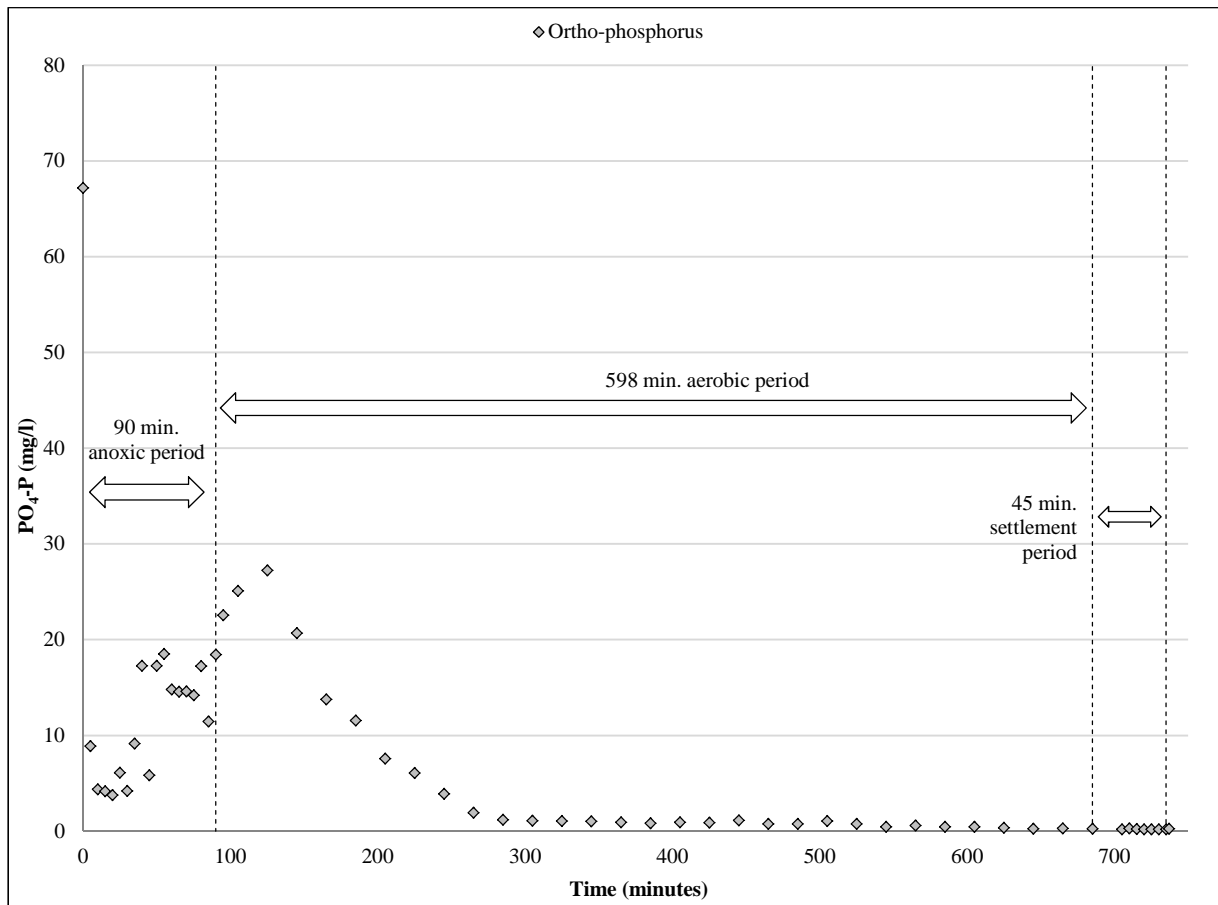

D 1.2.4.1 Study 1- Phase 2 – HSWIS 5

	min.	COD _f mg/l	TN _f mg/l	NH ₄ -N mg/l	TON mg/l	NO ₂ -N mg/l	NO ₃ -N mg/l	PO ₄ -P mg/l
90 min anoxic period	Inf.	2036	87	126.65	0.16	0.26	0.1	60.52
	5	994		63.27	2.29	0.92	1.37	40.88
	10			61.4	6.78	1.32	5.46	28.54
	15			62.08	7.69	1.34	6.35	28.29
	20	165		61.49	7.61	1.32	6.29	26.69
	25			59.25	7.47	1.23	6.24	26.45
	30		46	56.64	7.08	1.11	5.97	28.43
	35			53.25	6.61	1.02	5.59	27.57
	40	130		51.64	6.44	1.014	5.426	27.48
	45			50.57	6.35	1.03	5.32	27.81
	50		58	47.43	6.12	1.02	5.1	27.70
	55			42.67	6.081	0.91	5.171	25.80
	60	87		39.77	6.19	0.88	5.31	26.70
	65			37.56	5.77	0.95	4.82	27.22
	70			36.35	5.95	0.94	5.01	28.44
	75			53.96	5.21	0.93	4.28	27.45
	80	86		49.31	5.13	0.86	4.27	27.86
	85		22	48.99	4.77	0.83	3.94	31.31
	90		36	48.74	4.46	0.77	3.69	32.86
598 min aerobic period	110		42	46.18	4.52	0.56	3.96	32.97
	130	73		44.72	4.29	0.53	3.76	33.19
	150			44.43	3.29	0.69	2.60	32.99
	170		45	44.41	3.49	0.94	2.55	35.67
	190			43.68	3.08	1.14	1.94	32.67
	210	65		41.99	4.85	1.65	3.20	32.79
	230			37.73	5.67	1.93	3.74	31.70
	250			33.15	7.00	2.36	4.64	31.39
	270			31.04	8.33	2.76	5.57	31.06
	290			28.76	9.25	3.29	5.96	30.93
	310	44		25.77	9.66	3.52	6.14	30.28
	330			22.80	11.29	3.95	7.34	29.91
	350			20.44	12.02	4.21	7.81	29.51
	370			14.64	12.32	4.51	7.81	28.64
	390	39		11.78	13.17	4.62	8.55	27.50
	410		28	9.70	14.04	5.20	8.84	28.38
	430			7.75	14.14	5.30	8.84	28.24
	450			5.90	15.28	5.30	9.98	27.45
	470	46		5.23	15.86	5.18	10.68	27.34
	490			3.95	16.44	4.86	11.58	26.80
	510			3.12	16.30	4.63	11.67	27.48
	530			2.47	17.25	4.55	12.70	26.23
	550	39		1.95	17.19	4.43	12.76	26.32
	570		29	1.72	17.35	4.05	13.30	25.31
590			0.68	17.56	3.67	13.89	24.97	
610	37		0.29	17.84	2.82	15.03	24.68	
630			0.16	18.24	2.32	15.92	26.16	

D 1.2.4.1 Study 1- Phase 2 - HSWIS 5 (cont'd)

	min.	COD_f mg/l	TN_f mg/l	NH₄-N mg/l	TON mg/l	NO₂-N mg/l	NO₃-N mg/l	PO₄-P mg/l
A	650			0.23	17.87	1.99	15.88	24.50
	670			0.34	17.84	1.65	16.20	23.98
	690	48		0.18	18.23	1.31	16.92	23.96
	695			0.26	18.29	1.04	17.24	24.53
S	700			0.21	18.13	0.80	17.33	25.36
	705			0.18	18.16	0.07	18.09	25.36
	710			0.10	18.23	0.70	17.53	25.53
	715	68		0.21	18.15	0.68	17.47	24.93
	720			1.33	18.17	0.67	17.50	25.41
	725	65		0.13	18.06	0.67	17.39	25.18
	730			0.13	18.27	0.66	17.62	25.71
Eff.	737	63	24	0.25	18.34	0.66	17.68	25.04

A – Aerobic period cont'd; S- 45 min settlement period

D 1.2.4.2 Study 1 -Phase 2 – HSWIS 5

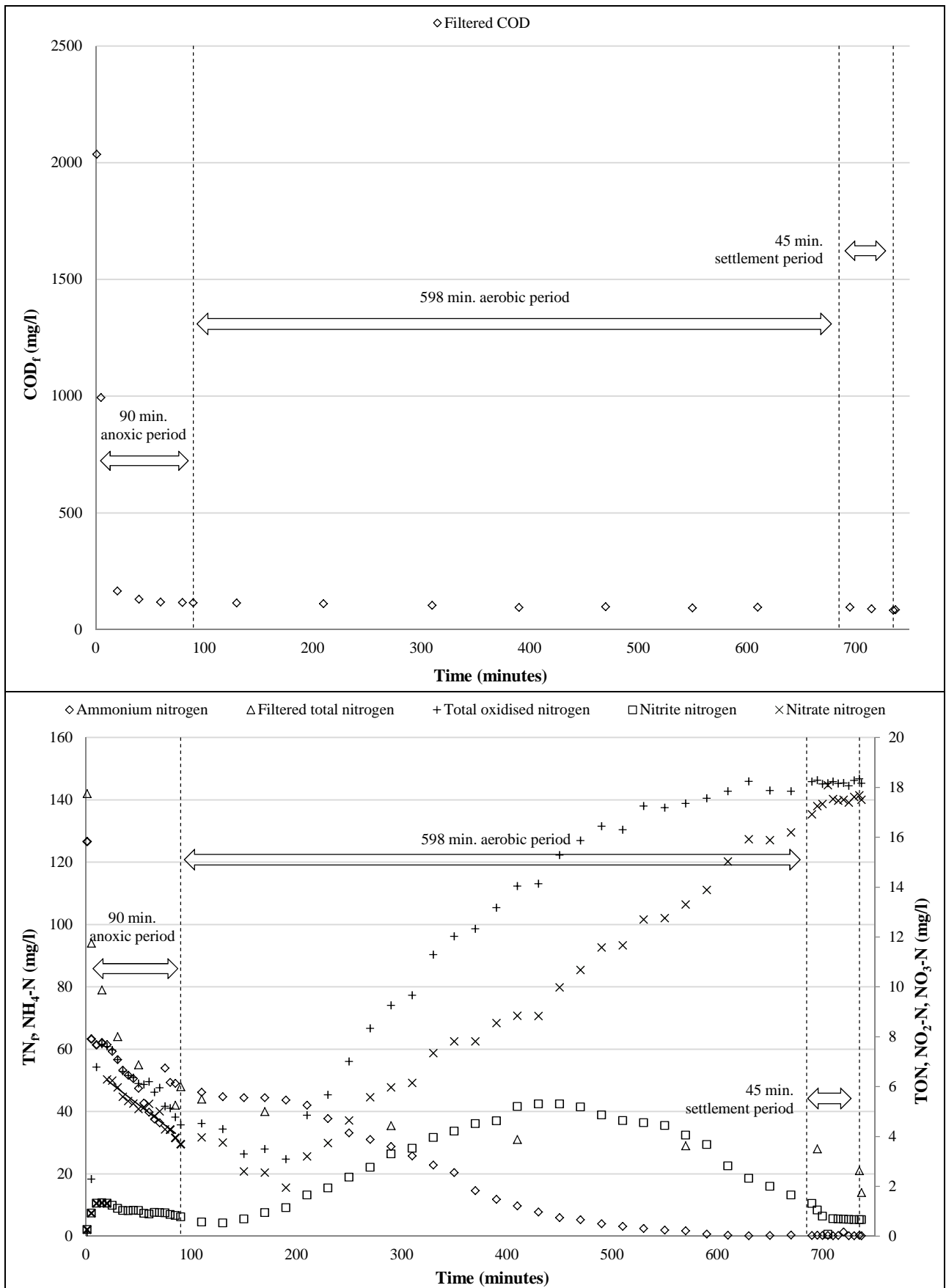

D 1.2.4.2 Study 1 –Phase 2 – HSWIS 5 (cont’d)

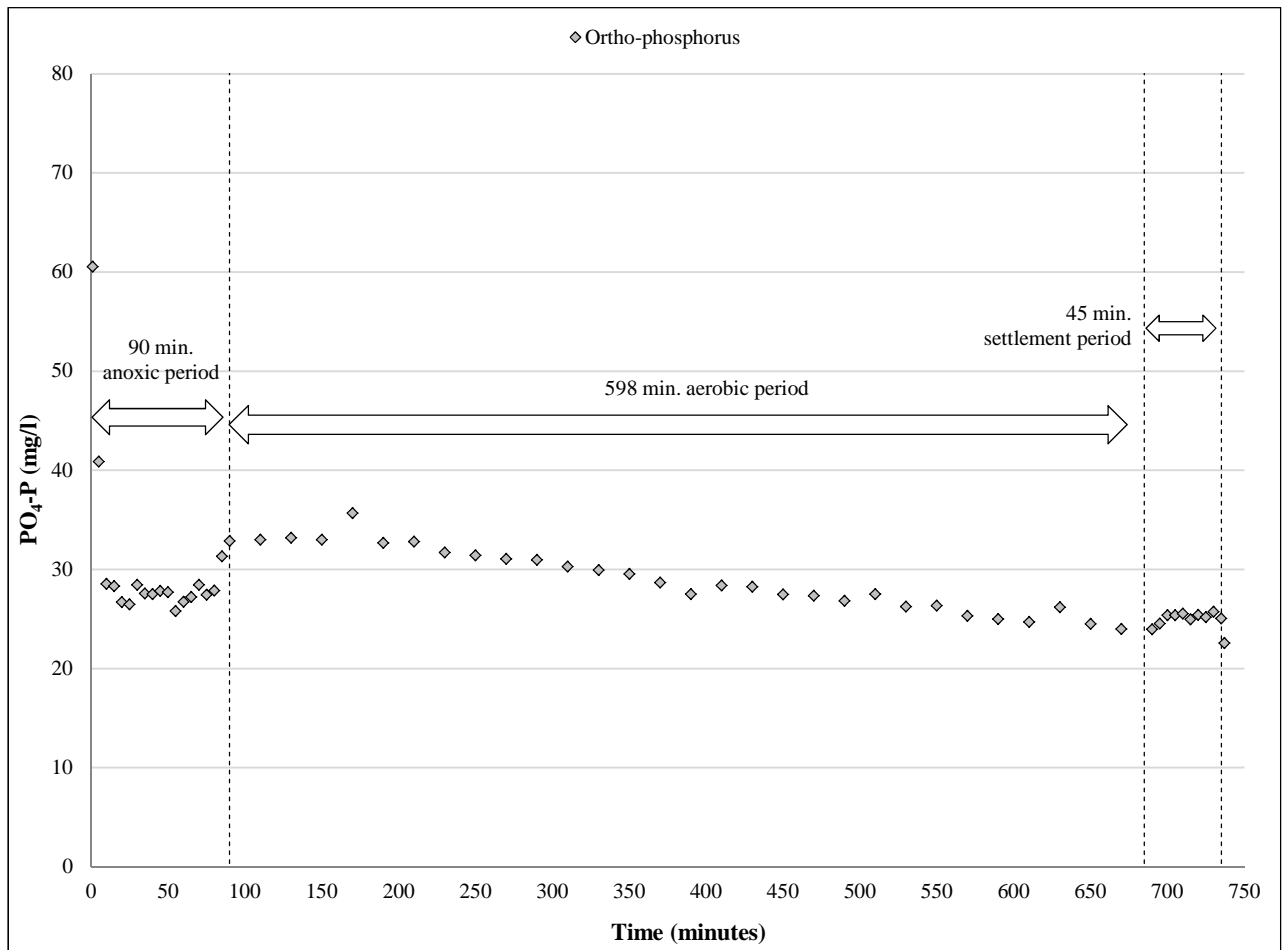

D 1.2.5.1 Study 2 - Phase 2 – HSWIS 6

	min.	COD _f mg/l	TN _f mg/l	NH ₄ -N mg/l	TON mg/l	NO ₂ -N mg/l	NO ₃ -N mg/l	PO ₄ -P mg/l
90 min anoxic period	0	1626	87	167.99	0.12	0.21	0.00	62.25
	5	267		93.57	1.96	0.71	1.26	24.02
	10			78.49	5.78	0.61	5.17	20.03
	15			76.77	6.29	0.58	5.71	20.07
	20			74.69	4.77	0.44	4.33	21.20
	25			76.81	4.39	0.45	3.95	20.85
	30	63	46	72.09	4.48	0.31	4.18	20.86
	35			69.46	3.86	0.40	3.46	20.69
	40	37		67.10	4.34	0.34	4.00	20.62
	45			65.25	3.63	0.33	3.30	20.59
	50		58	63.04	2.59	0.28	2.31	21.57
	55			63.13	1.63	0.30	1.33	22.37
	60			61.06	0.84	0.27	0.58	22.56
	65			59.37	0.51	0.28	0.23	23.01
	70	33		58.56	0.38	0.26	0.12	22.69
	75			56.79	0.68	0.32	0.37	22.25
	80	38		56.83	0.33	0.30	0.03	22.70
	85		22	54.23	0.23	0.15	0.08	24.16
	90	146	36	53.05	0.23	0.13	0.11	34.58
598 min aerobic period	110	175	42	48.88	0.21	0.17	0.04	40.41
	130			46.29	0.17	0.15	0.02	48.10
	150	65		44.53	0.14	0.15	-0.01	50.14
	170		45	36.81	0.57	0.31	0.26	45.24
	190			35.45	1.31	0.54	0.77	45.12
	210			33.54	2.62	1.00	1.62	43.82
	230	54		30.39	3.61	1.36	2.24	41.95
	250			28.42	4.78	1.79	2.99	39.83
	270	36		22.60	5.57	2.07	3.50	37.52
	290			23.65	6.66	2.44	4.22	36.67
	310			21.06	8.22	2.86	5.36	34.97
	330			18.68	9.62	3.32	6.30	33.71
	350	33		14.92	11.37	3.88	7.49	32.49
	370			14.11	12.53	4.19	8.34	30.99
	390	39		10.38	13.68	4.75	8.93	30.01
	410		28	10.37	13.95	4.87	9.08	28.50
	430	33		8.88	14.64	5.20	9.44	27.44
	450			6.62	15.74	5.61	10.13	27.04
	470			5.51	17.20	5.70	11.50	26.65
	490			4.08	18.36	5.75	12.61	25.68
	510			1.91	19.25	5.66	13.59	24.63
530			1.57	19.44	5.51	13.93	24.29	
550			0.66	19.92	4.88	15.04	23.59	
570	41	29	0.29	19.95	4.09	15.86	23.43	
590			0.18	20.17	3.53	16.64	22.82	
610			0.18	20.30	2.86	17.44	21.63	

D 1.2.5.1 Study 2 - Phase 2 - HSWIS 6 (cont'd)

	min.	COD_f mg/l	TN_f mg/l	NH₄-N mg/l	TON mg/l	NO₂-N mg/l	NO₃-N mg/l	PO₄-P mg/l
A	630			0.26	20.19	2.23	17.96	21.02
	650	106		0.36	20.18	1.75	18.43	20.01
	670			0.12	20.31	1.41	18.89	19.81
	690			0.09	19.96	0.98	18.98	19.31
	695	70		0.11	19.66	0.87	18.79	19.22
S	700			0.04	19.94	0.85	19.09	19.50
	705			0.11	20.13	0.86	19.27	19.68
	710			0.64	20.00	0.80	19.20	19.49
	715	53		0.15	19.73	0.80	18.93	19.46
	720			1.14	19.82	0.78	19.04	19.54
	725		30	0.11	19.77	0.70	19.06	19.56
	730	56		0.42	19.84	0.67	19.17	19.70
	735			0.55	20.20	0.16	20.04	7.05
Eff.	742	52	24	0.08	19.77	0.16	19.61	19.44

A – Aerobic period cont'd; S - 45 min settlement period

D 1.2.5.2 Study 1 – Phase 2 – HSWIS 6

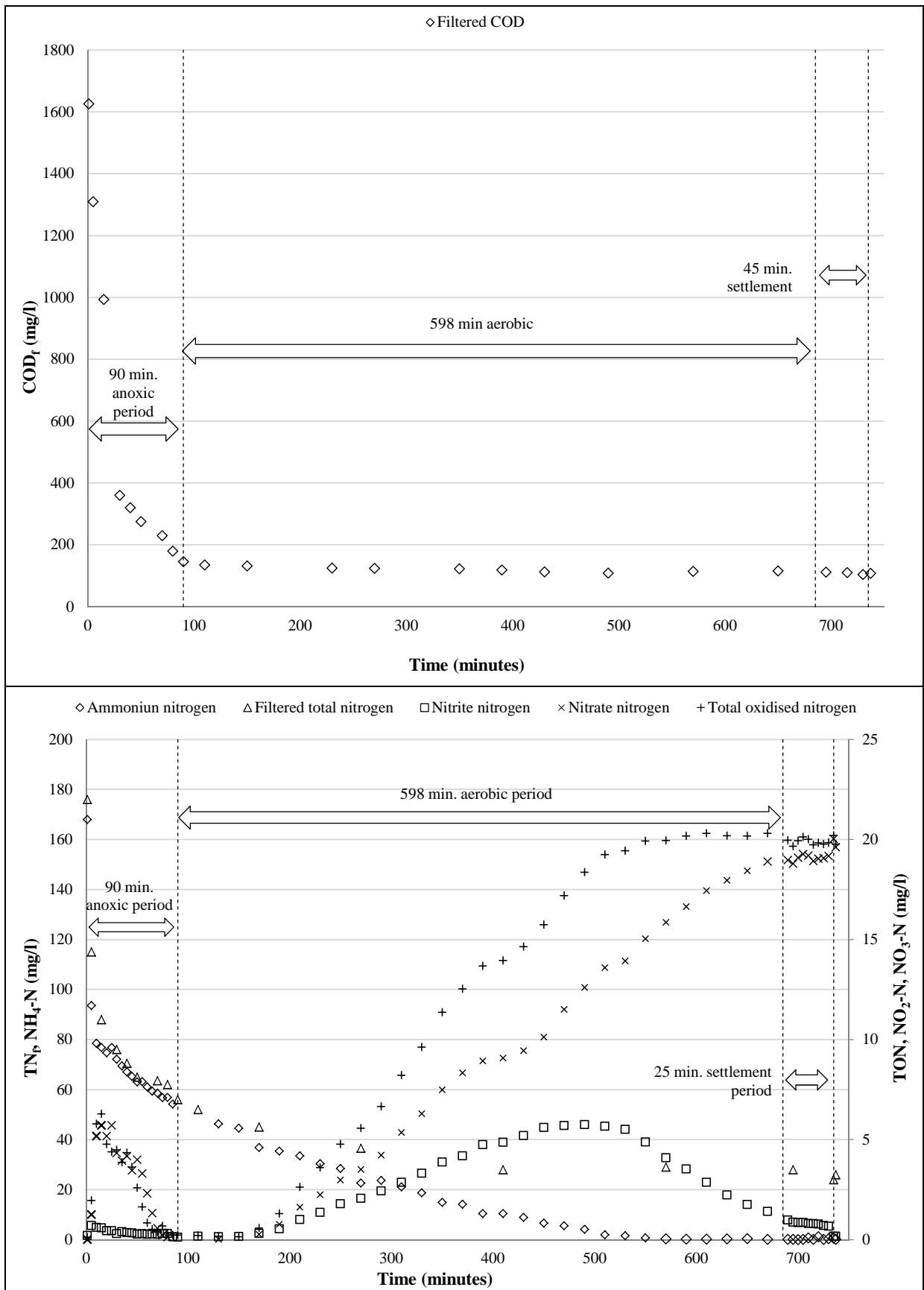

D 1.2.5.2 Study 1 – Phase 2 – HSWIS 6 (cont'd)

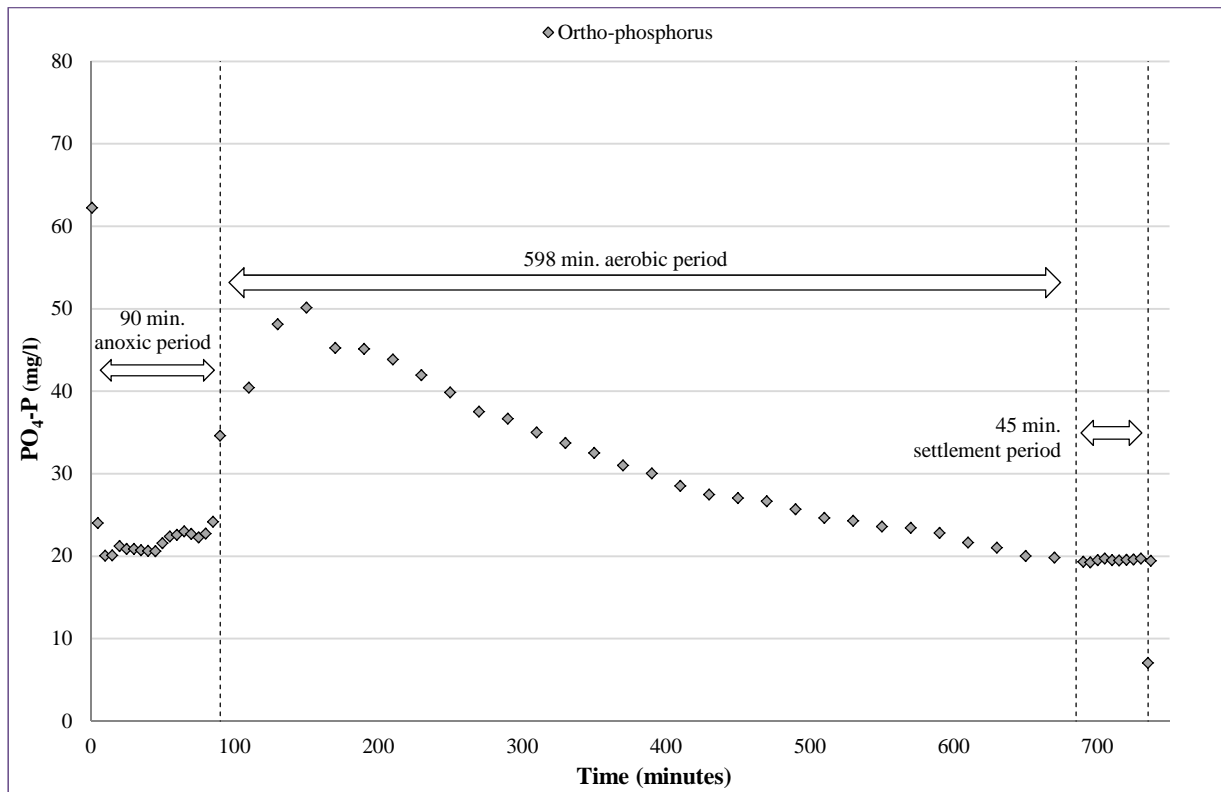

APPENDIX E

Municipal wastewater treatment results

E 2.1.1 Influent wastewater - Study 2 – Phase 1

Date	Day No.	SS mg/l	COD mg/l	COD _f mg/l	TN mg/l	TN _f mg/l	NH ₄ - N mg/l	TON mg/l	NO ₂ - N mg/l	NO ₃ - N mg/l	PO ₄ -P mg/l	Alk mg/l
16/11/11	29.1	80	253	125	-	-	21.14	0.15	0.02	0.13	0.78	-
17/11/11	30.2	20	162	105	-	-	30.55	0.89	0.08	0.81	1.72	-
22/11/11	35.1	145	127	62	-	-	29.56	1.33	0.23	1.09	1.68	-
23/11/11	36.2	115	-	-	-	-	32.26	0.89	0.02	0.87	1.78	-
24/11/11	37.4	70	-	-	-	-	33.91	2.15	0	2.15	1.91	-
05/12/11	48	75	144	87	45.32	54.76	30.55	0.00	0.08	0	1.72	-
07/12/11	50	105	227	120	-	-	22.48	2.28	0.26	2.02	1.23	-
08/12/11	51	120	228	90	66.024	19.58	29.56	0.73	0.23	0.50	1.68	-
09/12/11	52	95	260	106	-	-	20.40	2.20	0.10	2.10	1.86	-
12/12/11	55	85	167	103	51.59	44.53	25.24	0.00	0.03	0	1.71	-
14/12/11	57	15	65	56	18.25	13.72	18.07	3.13	0.19	2.94	0.85	-
16/12/11	59	15	-	-	-	-	18.50	1.73	0.12	1.61	0.71	-
19/12/11	62	30	-	-	-	-	18.70	1.16	0.03	1.13	0.80	-
20/12/11	63	10	85	49	20.66	17.71	12.25	2.02	0.26	1.77	0.70	-
21/12/11	64	35	45	27	21.28	18.72	8.94	2.62	0.07	2.55	1.05	-
22/12/11	65	45	-	-	-	-	7.12	2.53	0.16	2.37	0.72	-
03/01/12	77	60	-	-	-	-	9.34	0.25	0.04	0.21	1.33	-
04/01/12	78	25	96	51	48.46	21.02	32.31	0.08	0.06	0.02	1.52	-
05/01/12	79	70	-	-	-	-	15.95	1.11	0.03	1.08	0.80	-
09/01/12	83	90	-	-	-	-	25.86	0.83	0.06	0.77	1.10	-
12/01/12	86	95	-	-	-	-	22.03	2.03	0.28	1.75	1.57	-
13/01/12	87	65	257	154	-	-	27.95	1.17	0.15	1.02	2.23	-
16/01/12	90	45	200	118	51.95	46.58	28.12	0.05	0.02	0.03	1.58	-
18/01/12	92	115	-	-	-	-	20.04	1.95	0.03	1.93	1.91	-
19/01/12	93	55	294	160	31.176	27.18	22.34	1.68	0.73	0.95	1.43	-
19/01/12	93	80	144	34	-	-	22.68	0.90	0.15	0.76	2.48	-
23/01/12	97	74	177	93	40.64	30.06	23.03	1.40	3.82	0	2.16	-

E 2.1.1 Influent wastewater - Study 2 – Phase 1 (cont'd)

Date	Day No.	SS mg/l	COD mg/l	COD_f mg/l	TN mg/l	TN_f mg/l	NH₄- N mg/l	TON mg/l	NO₂- N mg/l	NO₃- N mg/l	PO₄-P mg/l	Alk mg/l
25/01/12	99	102	-	-	33.95	32.18	16.15	0.00	0.01		2.48	-
25/01/12	99	150	256	102	47.38	29.63	21.03	0.00	0.01		2.37	-
26/01/12	100	155			41.00	26.93	21.72	7.82	0.07	7.74	2.44	-
27/01/12	101	30	254	165	20.43	17.01	17.03	0.81	0.31	0.49	1.91	-
31/01/12	105	236	-	-	23.44	18.52	18.49	0.00	0.01	0	1.50	-
02/02/12	107	215	489	136	33.51	21.33	18.35	0.64	0.01	0.63	1.41	-
03/02/12	108	167.5	481	128	33.39	30.86	28.98	0.12	0.13	0	2.79	-
03/02/12	108	113	354	118	34.96	30.84	20.73	1.10	0.68	0.42	2.45	-
06/02/12	111	125	-	-	35.04	31.64	18.32	0.06	0.02	0.04	3.43	-
27/02/12	132	27	276	115	53.43	44.00	24.36	4.40	2.78	1.62	5.74	-
28/02/12	133	60	-	-	40.64	37.01	22.93	1.66	0.12	1.53	1.46	-
29/02/12	134	94	-	-	48.32	42.21	22.13	0.00	0.04	0	1.94	-
02/03/12	136	93	175	60	38.92	33.31	20.46	0.00	0.18	0	1.67	-
05/03/12	139	27	200	52	40.82	32.11	21.34	0.00	0.11	0	2.05	-
07/03/12	141	97	-	-	46.13	39.89	39.22	0	0.02	0	3.67	-
08/03/12	142	117	278	75	40.13	38.12	38.82	1.02	0.91	1.11	2.36	-
12/03/12	146	103	-	-	48.26	39.23	40.77	0	0.03	0	2.72	-
12/03/12	146	70	-	-	45.02	40.97	39.88	0	0.03	0	2.81	-
13/03/12	147	53	-	-	49.43	40.07	41.24	0	0.03	0	2.64	-
15/03/12	149	80	-	-	-	-	45.22	0	0.02	0	3.67	-
16/03/12	150	108	279	112	49.65	44.28	44.74	0	0.05	0	2.67	-
20/03/12	154	88	319	179	44.52	42.63	44.91	1.05	0.10	0.96	3.58	-
21/03/12	155	95	376	147	58.01	52.03	54.34	0.89	0.09	0.80	3.61	-
22/03/12	156	90	591	390	58.49	57.31	55.27	0.55	0.07	0.48	3.65	-
26/03/12	160	88	-	-	59.88	54.69	59.73	0.73	0.04	0.69	3.38	-
28/03/12	162	77	529	355	78.65	72.78	70.44	0	0.05	0	3.98	-
29/03/12	163	98	584	349	73.18	74.63	70.66	0	0.04	0	4.07	-

E 2.1.2 Effluent wastewater - Study 2 – Phase 1

Date	Day No.	SS mg/l	COD mg/l	COD _f mg/l	TN mg/l	TN _f mg/l	NH ₄ - N mg/l	TON mg/l	NO ₂ - N mg/l	NO ₃ - N mg/l	PO ₄ -P mg/l	Alk mg/l
02/04/12	167	98	364	218	69.82	65.60	67.18	0	0.00	0.00	2.75	-
16/11/11	29.1	45	65	43	-	-	4.70	22.94	1.06	21.88	0.25	-
17/11/11	30.2	20	55	66	-	-	3.87	21.90	0.56	21.34	0.29	-
22/11/11	35.1	115	43	31	-	-	4.62	23.26	1.27	21.99	0.26	-
06/12/11	48.9	25	91	53	46.98	44.78	1.11	30.10	1.63	28.46	0.61	-
07/12/11	50.3	15	33	28	-	-	3.98	31.72	1.53	30.19	0.49	-
08/12/11	51.0	35	50	18	-	-	0.90	14.20	0.21	14.00	0.46	-
09/12/11	51.9	25	39	26	46.55	36.22	0.14	28.71	0.71	28.00	0.55	-
13/12/11	55.9	20	-	-	-	-	1.56	23.26	1.06	22.20	0.42	-
14/12/11	56.9	20	42	37	41.83	40.28	1.07	26.14	1.32	24.82	0.28	-
14/12/11	57.2	35	-	-	35.14	33.91	0.23	23.19	0.17	23.02	0.54	-
15/12/11	58.0	55	30	23	-	-	1.05	30.81	0.08	30.73	0.43	-
16/12/11	59.1	15	-	-	-	-	0.30	18.34	0.04	18.30	0.37	-
20/12/11	63.0	70	-	-	-	-	0.84	18.13	0.06	18.06	0.22	-
20/12/11	63.2	55	41	20	28.62	22.2	1.1	12.83	0.10	12.77	0.25	-
21/12/11	64.1	45	-	-	-	-	2.8	9.35	0.21	9.17	0.79	-
22/12/11	65.1	25	107	36	23.83	15.2	0.9	12.73	0.25	12.51	0.62	-
04/01/12	78.0	90	84	23	-	-	1.4	19.66	0.82	18.90	0.46	-
04/01/12	78.2	80	-	-	-	-	2.94	16.85	0.16	16.69	0.49	-
05/01/12	79.0	100	-	-	-	-	7.64	31.29	1.42	29.87	0.44	-
05/01/12	79.2	80	106	68	30.90	28.78	0.81	27.16	0.04	27.12	0.67	-
12/01/12	85.9	95	-	-	-	-	2.87	9.68	2.73	6.95	1.51	-
12/01/12	86.2	50	-	-	-	-	2.98	25.72	2.61	23.11	0.63	-
13/01/12	86.9	20	86	54	-	-	8.17	27.50	2.74	24.76	0.37	-
17/01/12	90.9	50	-	-	36.93	33.16	5.24	28.98	2.42	26.56	0.49	-
18/01/12	91.9	50	55	40	-	-	2.07	36.54	1.89	34.65	0.51	-
19/01/12	92.9	85	62	38	39.60	38.92	0.12	41.65	0.63	41.02	0.70	-

E 2.1.2 Effluent wastewater - Study 2 – Phase 1 (cont'd)

Date	Day No.	SS mg/l	COD mg/l	COD _f mg/l	TN mg/l	TN _f mg/l	NH ₄ - N mg/l	TON mg/l	NO ₂ - N mg/l	NO ₃ - N mg/l	PO ₄ -P mg/l	Alk mg/l
19/01/12	93.3	30	51	32	-	-	0.07	37.18	0.02	37.16	0.68	-
24/01/12	98.1	34	53	26	28.21	10.97	0.86	22.40	0.72	21.68	0.70	-
25/01/12	99.2	32.5	59	51	49.20	29.85	0.20	23.37	0.11	23.26	0.82	-
26/01/12	100.2	23	-	-	35.47	28.43	0.46	24.77	0.06	24.71	0.93	-
27/01/12	101.2	73	-	-	23.10	21.95	0.43	21.16	0.11	21.06	1.04	-
30/01/12	104.1	86	65	40	25.91	21.28	1.66	18.35	0.31	18.04	1.74	-
31/01/12	105.0	62	-	-	44.72	22.08	1.72	19.98	0.17	19.81	0.60	-
01/02/12	106.0	30	21	19	23.00	22.99	0.22	23.13	0.10	23.03	0.94	-
02/02/12	107.1	43	44	27	20.71	19.53	1.29	21.30	0.05	21.25	0.94	-
02/02/12	107.2	9	-	-	23.62	21.32	1.52	25.38	0.14	25.24	2.59	-
03/02/12	108.0	40	53	40	27.44	27.02	1.35	20.35	0.75	19.60	2.35	-
03/02/12	108.4	57	79	35	29.74	24.931	0.77	31.80	0.77	31.02	1.41	-
06/02/12	111.4	57	-	-	-	-	1.25	37.61	0.71	36.90	1.30	-
07/02/12	112.0	15	15	-	-	-	38.03	1.13	36.90	1.61	1.28	-
07/02/12	112.1	20	20	-	-	-	39.27	0.63	38.65	1.61	1.02	-
24/02/12	129.0	280	-	-	19.19	15.53	4.50	11.49	0.15	11.34	0.99	-
28/02/12	133.0	197	57	33	26.90	24.62	8.10	14.42	0.40	14.02	4.01	-
02/03/12	136.0	467	79	44	24.08	20.87	5.17	5.10	0.80	4.30	0.92	-
06/03/12	139.9	220	69	43	25.19	24.50	0.37	24.78	0.67	24.11	1.46	-
06/03/12	140.0	193	-	-	25.31	24.69	1.11	20.17	0.65	19.52	1.47	-
07/03/12	141.1	133	-	-	32.11	18.49	2.26	19.34	0.56	18.79	1.60	-
08/03/12	142.0	230	84	38	33.14	28.00	4.498	20.34	0.56	19.78	1.90	-
13/03/12	147.0	180	-	-	35.12	29.65	5.81	26.15	0.62	25.54	1.43	-
15/03/12	149.2	78	-	-	34.85	26.44	8.69	23.81	0.603	23.20	2.352	-
16/03/12	150.2	63	85	55	36.13	27.55	7.45	28.22	0.55	27.67	1.99	-
21/03/12	155.0	133	125	40	20.12	21.71	3.63	18.66	0.41	18.25	1.91	-
22/03/12	155.9	140	124	34	18.12	16.83	4.58	17.14	0.52	16.61	2.08	-

E 2.1.2 Effluent wastewater - Study 2 – Phase 1 (cont'd)

Date	Day No.	SS mg/l	COD_t mg/l	COD_f mg/l	TN_t mg/l	TN_f mg/l	NH₄- N mg/l	TON mg/l	NO₂- N mg/l	NO₃- N mg/l	PO₄-P mg/l	Alk mg/l
22/03/12	156.2	115	126	57	28.18	18.15	4.66	19.31	0.56	18.75	1.75	-
23/03/12	156.9	133	-	-	20.92	19.07	16.20	19.10	0.77	18.33	1.88	-
28/03/12	161.9	50	-	-	18.12	18.03	8.44	12.55	0.68	11.87	2.00	-
28/03/12	162.3	33	124	42	24.23	18.47	8.45	11.55	0.87	10.68	1.25	-
28/03/12	162.3	33	124	42	24.23	18.47	8.45	11.55	0.87	10.68	1.25	-
29/03/12	163.0	23	124	52	19.37	17.08	8.48	3.33	0.77	2.57	2.44	-
30/03/12	164	75	126	53	22.57	20.16	11.44	2.41	0.392	2.02	2.70	-
03/04/12	168.0	98	130	44	29.17	24.86	2.07	24.72	1.34	23.38	1.34	-
04/04/12	169.0	88	117	57	22.01	21.64	9.8	12.15	0.75	11.40	1.87	-
05/04/12	170.0	35	-	-	24.95	19.25	4.15	18.06	0.63	17.42	2.52	-
05/04/12	170.2	92	125	48	19.75	18.93	7.65	13.40	0.80	12.60	2.19	-
11/04/12	175.9	45	-	-	18.31	16.10	7.13	9.85	1.22	8.64	2.20	-
11/04/12	176.2	85	126	58	24.51	18.88	7.03	12.55	1.14	11.42	2.00	-
12/04/12	177.0	77	-	-	24.06	22.61	6.45	14.21	0.87	13.34	3.03	-
12/04/12	177.3	91	-	-	25.20	24.35	5.28	14.11	0.61	13.50	2.31	-
13/04/12	177.9	90	120	63	22.29	21.95	2.21	21.12	0.77	20.35	2.90	-
17/04/12	181.9	75	-	-	23.11	22.72	4.32	23.33	0.762	22.56	3.23	177.09
17/04/12	182.3	108	101	50	22.66	21.77	4.10	22.25	0.82	21.43	3.14	188.09
18/04/12	183.0	68	101	55	25.53	22.56	2.80	24.69	0.45	24.24	3.02	111.62
19/04/12	183.9	30	100	51	27.01	21.55	5.17	23.27	0.50	22.77	2.10	127.45
19/04/12	184.3	38	-	-	25.9	23.9	9.04	23.25	0.65	22.59	2.10	132.51
20/04/12	184.9	10	132	57	30.6	22.1	8.22	22.68	0.02	22.66	1.64	131.23
24/04/12	188.9	35	108	53	28.59	21.67	5.91	15.35	6.77	8.59	2.08	148.39
24/04/12	189.3	43	101	63	22.21	18.59	6.45	12.88	2.32	10.56	1.86	167.81
25/04/12	189.9	21	-	-	20.44	19.36	4.68	16.68	0.67	16.01	2.25	182.48
25/04/12	190.3	25	77	51	19.62	17.34	3.88	18.74	0.38	18.36	2.18	194.83

E 2.1.2 Effluent wastewater - Study 2 – Phase 1 (cont'd)

Date	Day No.	SS mg/l	COD _t mg/l	COD _f mg/l	TN _t mg/l	TN _f mg/l	NH ₄ - N mg/l	TON mg/l	NO ₂ - N mg/l	NO ₃ - N mg/l	PO ₄ -P mg/l	Alk mg/l
27/04/12	192.0	32	-	-	22.54	21.82	5.97	21.41	0.41	20.99	2.08	209.97
01/05/12	196.0	95	-	-	21.489	20.35	7.00	22.67	0.61	22.06	2.33	143.83
02/05/12	196.9	30	-	-	25.254	24.79	7.25	22.65	0.56	22.09	2.47	140.24
02/05/12	197.0	38	-	-	26.658	23.09	8.61	22.65	0.59	22.06	2.12	132.13
03/05/12	197.9	22	101	48	-	-	7.88	22.36	0.54	21.82	2.66	155.02
03/05/12	198.0	35	-	-	-	-	6.40	22.87	0.52	22.34	2.71	164.67
04/05/12	199.0	48	98	56	28.05	24.98	5.84	23.79	3.06	20.74	2.53	204.14
04/05/12	199.1	100	-	-	-	-	6.57	23.15	0.92	22.23	2.31	194.48
09/05/12	203.9	133	111	66	42.90	31.41	7.33	22.90	1.07	21.83	2.72	222.31
09/05/12	204.3	110	-	-	49.40	35.85	6.65	20.30	0.98	19.31	2.95	134.31
10/05/12	205.0	33	102	53	35.48	30.45	3.18	29.17	1.09	28.08	3.26	93.27
10/05/12	205.2	47.5	-	-	35.68	29.57	4.33	29.81	1.78	28.03	1.86	177.09
11/05/12	206.0	158	-	-	-	-	6.21	27.11	0.94	26.17	2.08	188.09
15/05/12	210.0	60	128	50	30.28	26.96	5.23	24.11	1.51	22.60	1.75	132.51
15/05/12	210.1	98	-	-	26.98	26.75	6.65	21.56	0.21	21.35	1.88	111.62
16/05/12	211.0	68	-	-	30.33	25.20	5.74	23.21	0.45	22.76	2.00	127.45
16/05/12	211.2	113	125	56	31.92	28.62	6.23	20.18	0.97	19.21	1.25	128.25
17/05/12	212.0	60	-	-	28.92	24.51	4.88	21.01	1.02	19.99	2.44	131.23
17/05/12	212.3	35	-	-	29.81	28.07	3.79	25.36	0.98	24.38	2.70	135.20
18/05/12	212.9	78	-	-	27.42	26.83	5.55	24.78	0.44	24.34	2.47	148.39

E 2.1.3.1 Study 2 Phase 1 – MWIS 1

	min.	COD	COD _f	TN	TN _f	NH ₄ -N	TON	NO ₂ -N	NO ₃ -N	PO ₄ -P	
		mg/l	mg/l	mg/l	mg/l	mg/l	mg/l	mg/l	mg/l	mg/l	
465 min. aerobic period	Inf.	0	238	147	32.24	27.07	24.34	0.01	0.00	0.01	1.35
	0.5						10.27	6.00	0.20	5.80	0.73
	1	162	84	25.4	20.5	9.75	6.78	0.21	6.57	0.62	
	5					8.92	6.57	0.24	6.33	0.86	
	10	139	79	20.72	19.5	8.88	7.02	0.31	6.72	0.59	
	15					8.22	6.79	0.42	6.37	0.64	
	20	132	74	25.05	19.02	8.60	6.48	0.48	6.00	0.38	
	25					7.96	6.94	0.46	6.48	0.55	
	30	103	58	18.78	16.58	7.93	7.64	0.48	7.16	0.52	
	35					7.69	7.51	0.66	6.85	0.68	
	40					7.20	7.95	0.63	7.32	0.47	
	45	113	53	24.94	17.50	7.07	8.66	0.64	8.02	0.78	
	60					6.31	8.15	0.60	7.55	0.35	
	75	95	55	23.16	15.89	5.60	9.71	0.56	9.15	1.14	
	90					6.67	9.52	0.73	8.79	0.81	
	105	75	53	26.61	16.40	6.46	9.25	0.90	8.35	0.68	
	120					5.73	10.09	0.99	9.11	0.35	
	135	64	47	25.18	17.59	5.41	11.12	1.00	10.12	1.03	
	150					4.36	12.81	1.15	11.65	1.01	
	165	55	49	22.88	16.12	3.86	11.49	1.39	10.10	1.43	
	180					3.19	11.79	1.26	10.53	0.70	
	195	67	46			3.17	13.03	1.35	11.68	0.69	
	210					2.75	12.27	1.34	10.92	0.66	
	225	61	52	23.57	16.58	2.17	12.43	1.39	11.03	0.59	
	240					1.53	13.43	1.32	12.12	0.62	
	255					1.79	13.80	1.40	12.40	0.57	
	270					1.25	13.58	1.44	12.14	0.58	
	285	66	47	22.99	17.73	1.02	14.54	1.51	13.03	0.47	
	300					0.52	14.60	1.47	13.13	0.48	
	315	60	59			0.33	15.27	1.41	13.86	0.36	
	330					1.01	16.04	1.37	14.67	0.36	
	345	64	47	22.3	16.432	0.24	15.65	1.37	14.28	0.28	
	360					0.47	17.40	1.30	16.10	0.35	
	375	63	44	22.62	18.80	0.61	16.82	1.23	15.60	0.27	
	390					0.85	17.99	1.12	16.87	0.37	
	405					1.00	17.12	0.94	16.19	0.51	
	420	65	55			1.05	20.03	0.84	19.19	0.27	
	435			22.55	19.08	1.10	19.20	0.73	18.46	0.31	
	450					1.15	20.35	0.64	19.72	0.20	
	S	465	51	50			1.22	21.05	0.58	20.48	0.19
		480					1.25	21.51	0.55	20.96	0.21
		485			22.70	18.23	1.22	21.12	0.49	20.63	0.30
		490					1.16	21.14	0.48	20.67	0.25

E 2.1.3.1 Study 2 Phase 1 – MWIS 1 (cont'd)

	min.	COD	COD_f	TN	TN_f	NH₄-N	TON	NO₂-N	NO₃-N	PO₄-P
		mg/l	mg/l	mg/l	mg/l	mg/l	mg/l	mg/l	mg/l	mg/l
S	495	67	48	22.72	20.46	1.06	21.79	0.46	21.33	0.16
Eff.	510	51	47	22.80	20.12	1.27	21.05	0.39	20.66	0.24

S – 45 min settlement period

E 2.1.3.2 Study 2 Phase 1 – MWIS 1

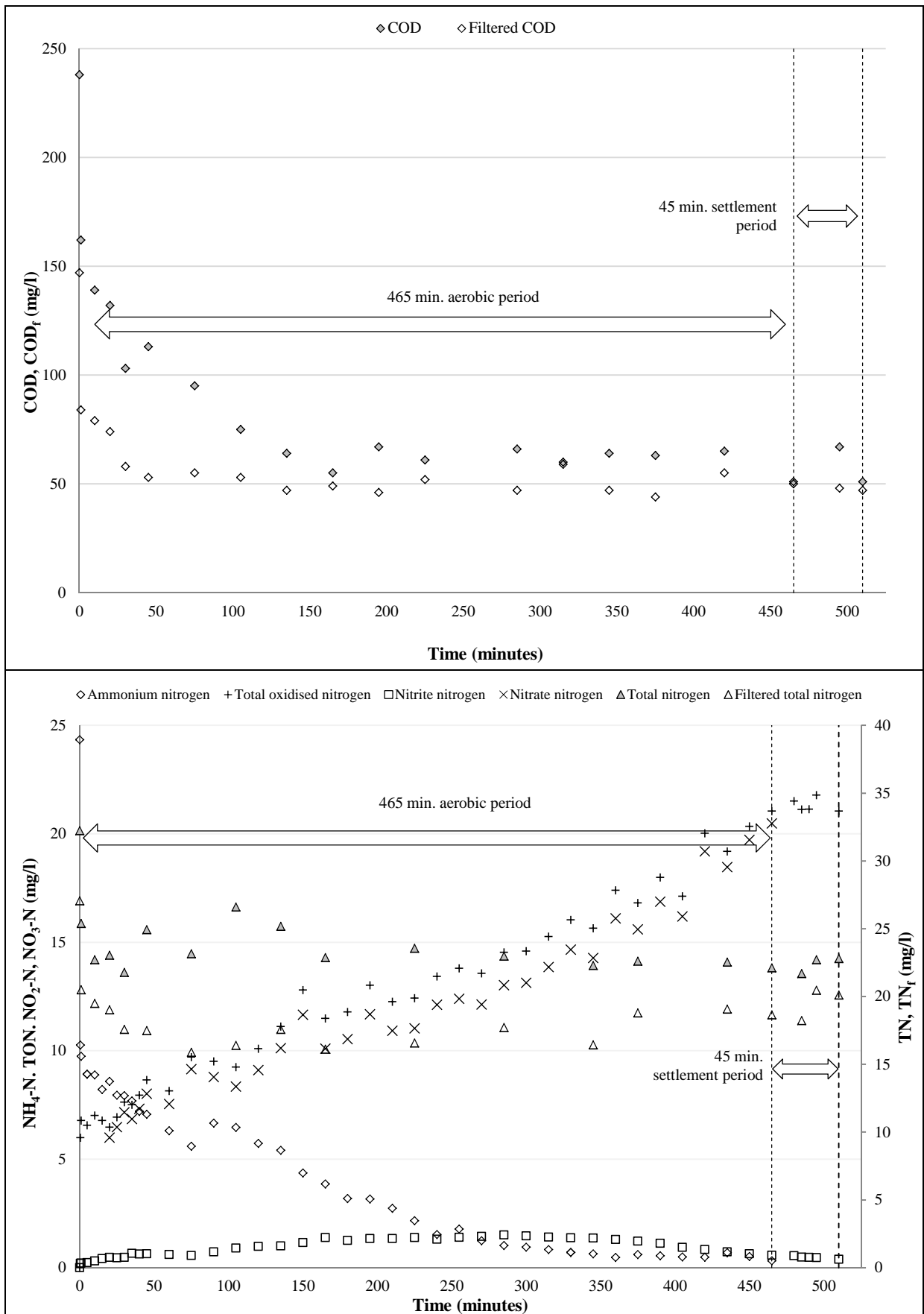

E 2.1.3.2 Study 2 Phase 1 – MWIS 1 (cont'd)

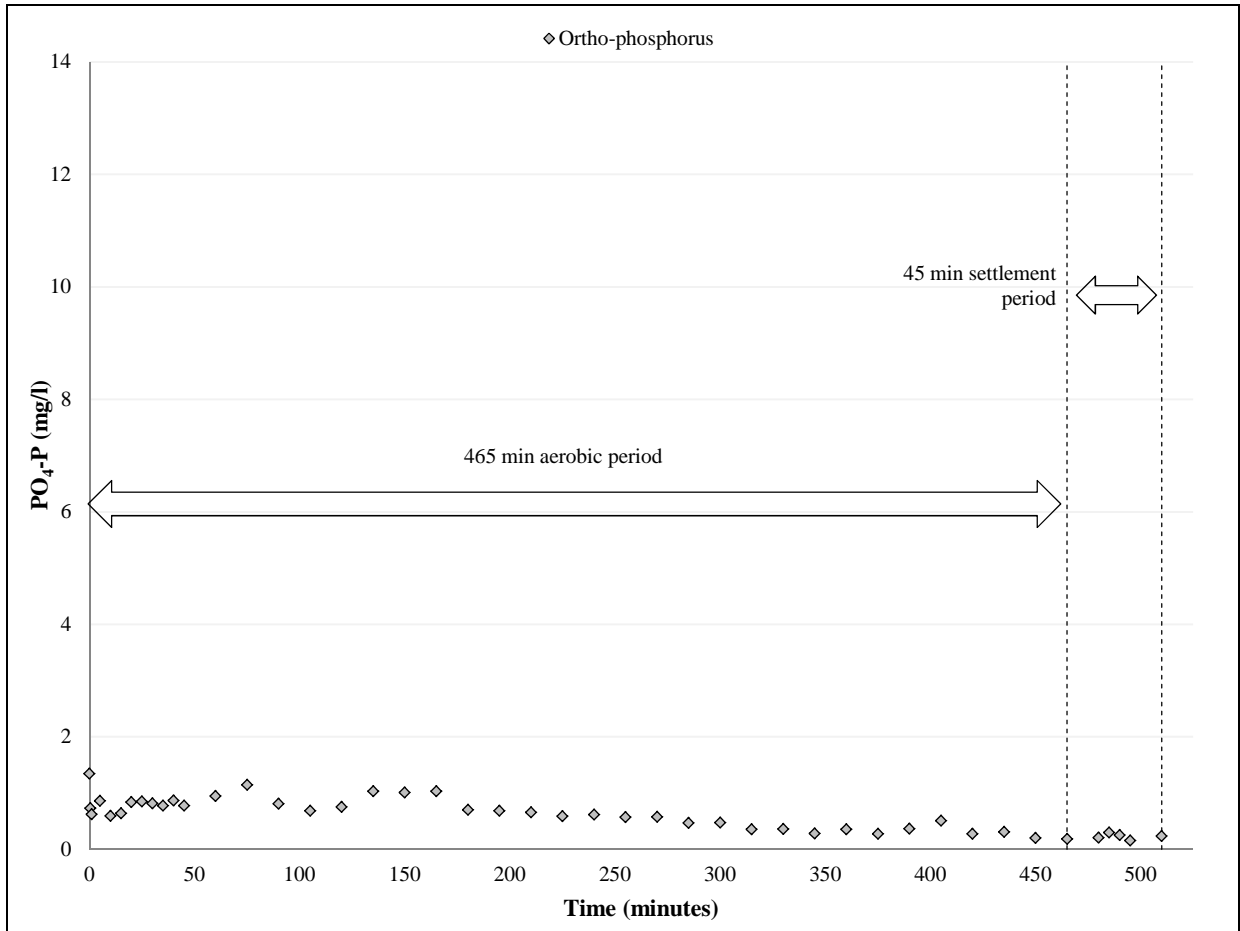

E 2.1.4.1 Study 2- Phase 1 - MWIS 2.

	min.	COD	COD _f	TN	TN _f	NH ₄ -N	TON	NO ₂ -N	NO ₃ -N	PO ₄ -P
		mg/l	mg/l	mg/l	mg/l	mg/l	mg/l	mg/l	mg/l	mg/l
465 min. aerobic period	0	310	126	38.28	33.39	27.22	1.93	1.04	0.89	2.25
	0.5					13.26	8.35	0.31	8.05	1.98
	1					9.84	8.43	0.30	8.13	1.74
	5					7.38	8.53	0.32	8.21	1.38
	10	260	115	33.31	24.78	7.07	8.55	0.23	8.31	1.45
	15					6.87	7.79	0.30	7.49	1.24
	20	224	72	22.94	18.38	6.46	7.79	0.37	7.41	1.26
	25					5.85	7.82	0.26	7.56	1.38
	30	197	51	24.47	16.88	5.85	7.51	0.33	7.19	1.26
	35					5.63	8.24	0.39	7.85	1.35
	40					5.41	8.12	0.39	7.73	1.53
	45					5.28	8.02	0.41	7.61	1.51
	60	131	46	24.10	19.30	5.16	7.97	0.46	7.52	1.40
	75					5.60	7.88	0.39	7.49	1.23
	90	114	40	23.42	12.05	4.60	39.00	0.46	7.88	1.24
	105					4.91	8.34	0.43	6.86	1.21
	120	105	40	23.42	12.05	4.86	7.29	0.46	7.14	1.28
	135					4.85	7.60	0.53	7.28	1.32
	150	110	39	18.60	15.00	4.87	7.81	0.54	7.76	1.17
	165					5.04	8.30	0.52	8.51	1.30
	180	102	38	17.70	15.25	4.66	9.03	0.54	8.87	1.13
	195					4.28	9.41	0.56	8.36	1.29
	210	97	38	18.52	16.81	3.67	8.92	0.56	8.35	1.26
	225					2.24	8.91	0.59	8.29	1.37
	240	96	37	18.12	16.30	2.95	8.88	0.61	8.90	1.45
	255					2.71	9.51	0.61	8.96	1.42
	270	91	38	16.85	15.66	2.41	9.57	0.59	7.69	1.52
	285					2.51	8.28	0.59	10.38	1.23
	300	99	53	17.66	14.49	2.17	10.96	0.59	9.59	1.12
	315					1.51	10.18	0.59	10.57	1.17
	330	91	40	18.42	15.54	1.05	11.16	0.55	11.19	1.29
345					0.98	11.75	0.61	11.76	1.28	
360	88	45	19.98	15.43	0.85	12.37	0.62	13.05	1.28	
375					0.74	13.66	0.62	12.00	1.12	
390	86	42	22.08	19.91	0.82	12.61	0.65	12.67	1.24	
405					0.59	13.31	0.65	13.72	1.29	
420	83	46	24.23	19.81	0.49	14.37	0.66	14.70	1.47	
435					0.52	15.36	0.64	14.92	1.38	
450	88	44	24.06	20.46	0.42	15.56	0.65	15.98	1.40	
465					0.43	16.64	0.64	15.61	1.23	
480	90	38	23.99	21.82	0.55	16.24	0.64	17.98	1.36	
485					0.68	18.62	0.63	18.18	1.35	
490					0.55	18.81	0.61	18.49	1.33	
495					0.45	19.10	0.65	20.10	1.38	
Eff.	510	91	36	23.21	22.02	0.56	20.75	0.64	19.24	1.47

S - 45 minute settlement period

E 2.1.4.2 Study 2 - Phase 1 - MWIS 2

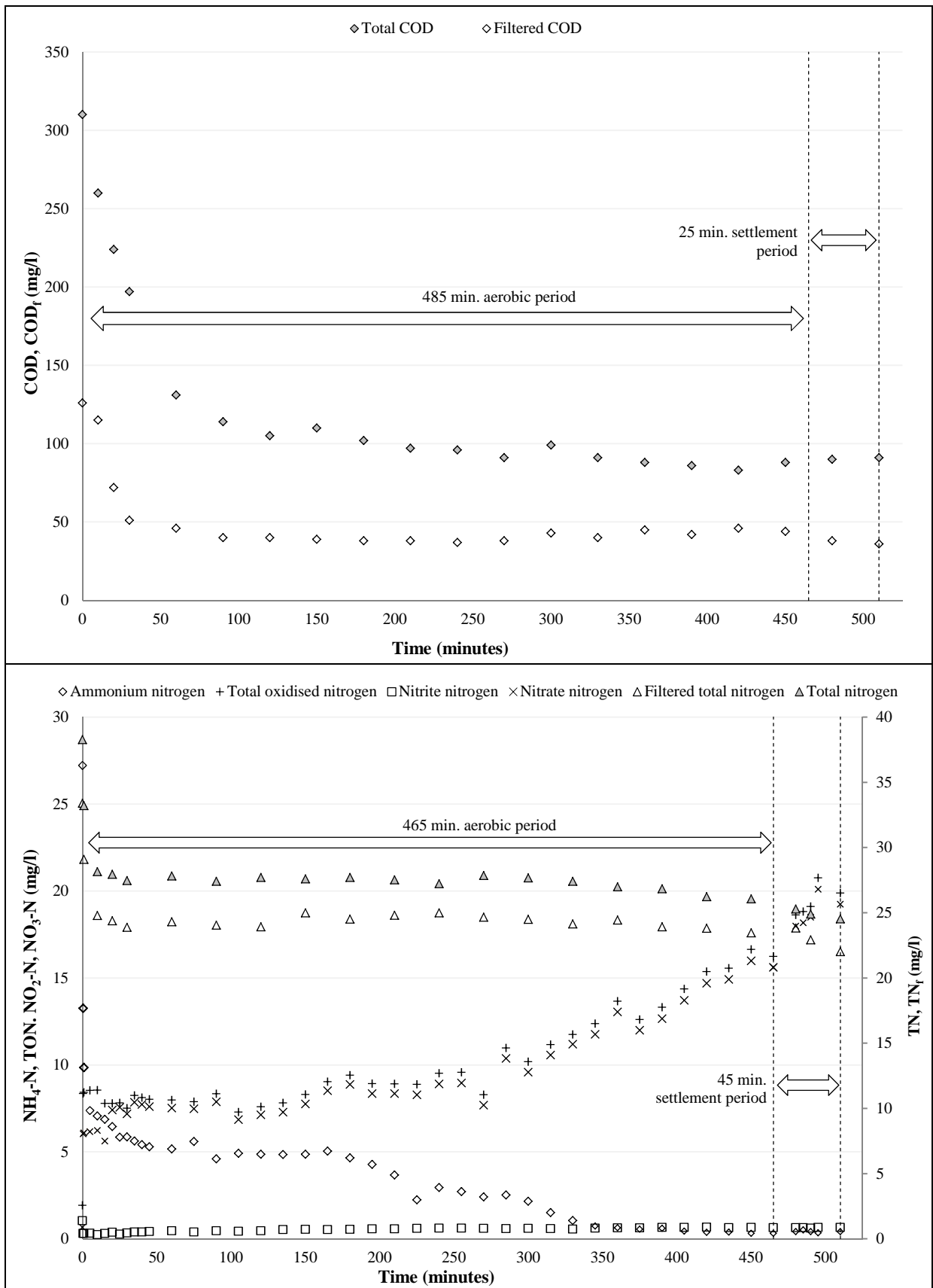

E 2.1.4.2 Study 2 - Phase 1 - MWIS 2 (cont'd)

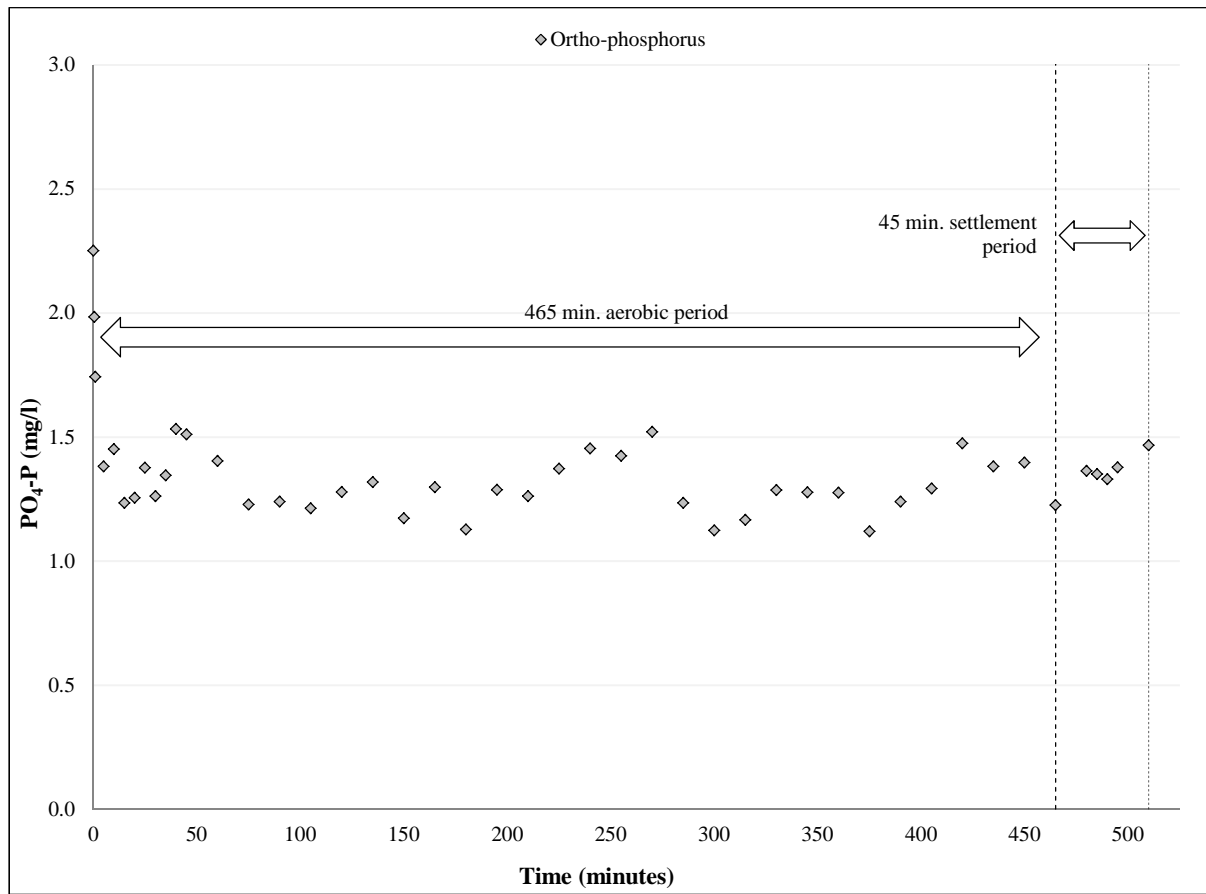

E 2.1.5.1 Study 1 - Phase 1 - MWIS 3

	min.	COD	COD _f	TN	TN _f	NH ₄ -N	TON	NO ₂ -N	NO ₃ -N	PO ₄ -P	
		mg/l	mg/l	mg/l	mg/l	mg/l	mg/l	mg/l	mg/l	mg/l	
465 min. aerobic period	Inf.	0	359	237	48.57	39.53	28.11	0.73	0.20	0.53	2.70
	0.5	200	106	25.05	20.33	14.93	9.67	0.11	9.55	2.29	
	1					10.88	8.69	0.14	8.56	2.18	
	5	252	116	23.05	21.83	10.07	8.73	0.15	8.58	2.13	
	10			22.98	22.81	9.83	7.75	0.14	7.61	2.26	
	15	269	104	21.89	21.11	9.81	7.74	0.15	7.59	2.07	
	20			21.93	20.18	9.42	7.79	0.16	7.63	2.12	
	25	270	92	22.33	20.34	9.10	7.85	0.22	7.63	2.19	
	30			21.30	19.82	10.87	8.28	0.18	8.09	2.16	
	35	218	86	21.08	19.23	9.47	8.22	0.20	8.02	2.25	
	40			21.35	19.48	9.30	8.87	0.24	8.63	2.39	
	45	198	88	20.98	19.82	9.17	8.85	0.27	8.58	2.17	
	60	185	84	19.39	18.22	9.09	8.86	0.31	8.55	2.17	
	75			18.44	17.95	9.78	8.90	0.33	8.57	2.29	
	90			18.52	16.93	8.35	9.04	0.36	8.68	2.14	
	105	185	65	18.08	17.20	9.13	8.98	0.41	8.57	2.14	
	120			16.75	16.56	8.99	9.10	0.45	8.65	2.10	
	135			18.18	16.10	8.09	8.96	0.43	8.53	2.15	
	150	155	62	16.80	16.73	8.13	9.22	0.49	8.74	2.18	
	165			16.26	15.94	7.68	9.05	0.51	8.55	2.01	
	180			15.62	15.15	7.44	9.89	0.49	9.40	2.07	
	195	164	62	16.37	14.79	7.16	9.88	0.53	9.35	2.01	
	210			16.19	15.65	7.07	10.11	0.49	9.62	2.20	
	225			15.65	15.56	7.22	9.82	0.52	9.30	2.20	
	240	139	55	16.36	14.75	6.19	9.99	0.50	9.50	2.31	
	255			19.31	15.62	6.29	9.86	0.52	9.34	2.13	
	270			15.25	15.17	6.10	10.90	0.35	10.55	2.13	
	285	116	58	15.11	14.48	6.07	10.18	0.52	9.66	2.17	
	300			15.18	14.62	5.85	10.91	0.49	10.42	2.23	
	315			15.12	14.45	5.05	11.86	0.53	11.33	2.27	
	330	113	60	14.32	14.24	4.47	12.55	0.48	12.07	2.09	
	345			14.61	13.68	4.51	12.68	0.49	12.19	2.16	
	360			14.62	13.76	3.84	13.00	0.53	12.47	1.96	
	375	111	52	14.57	13.81	3.19	13.82	0.54	13.29	1.96	
	390			12.98	13.79	2.86	13.63	0.49	13.14	1.99	
	405					3.08	14.69	0.53	14.16	2.08	
	420	121	57	13.86	13.73	2.94	13.91	0.52	13.40	2.20	
	435			13.99	13.17	2.66	14.88	0.49	14.40	2.22	
	450			13.43	13.02	2.29	15.74	0.51	15.23	2.09	
	465	95	55	13.45	13.15	2.19	15.67	0.51	15.17	2.12	
	480			13.20	12.96	1.56	16.27	0.49	15.78	2.21	
	485			14.00	13.09	1.37	16.75	0.47	16.28	2.33	
	490			13.00	13.21	1.26	16.20	0.53	15.68	2.06	
	495			14.03	13.44	1.16	16.84	0.42	16.42	1.98	
	Eff.	510	104	57	13.70	13.01	0.93	16.65	0.47	16.18	2.18

S - 45 minute settlement period

E 2.1.5.2 Study 1 - Phase 1 - MWIS 3

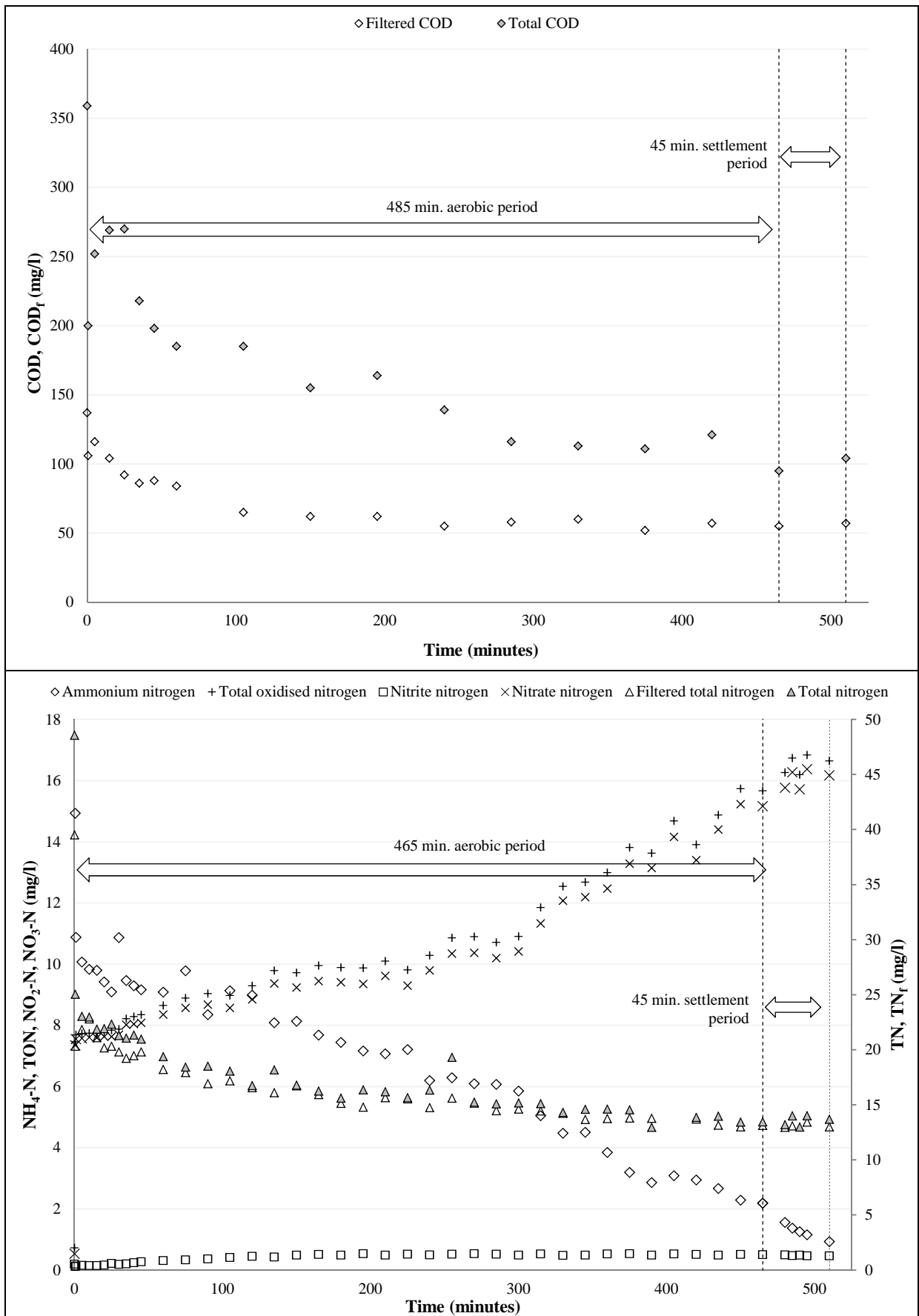

E 2.1.5.2 Study 1 - Phase 1 - MWIS 3 (cont'd)

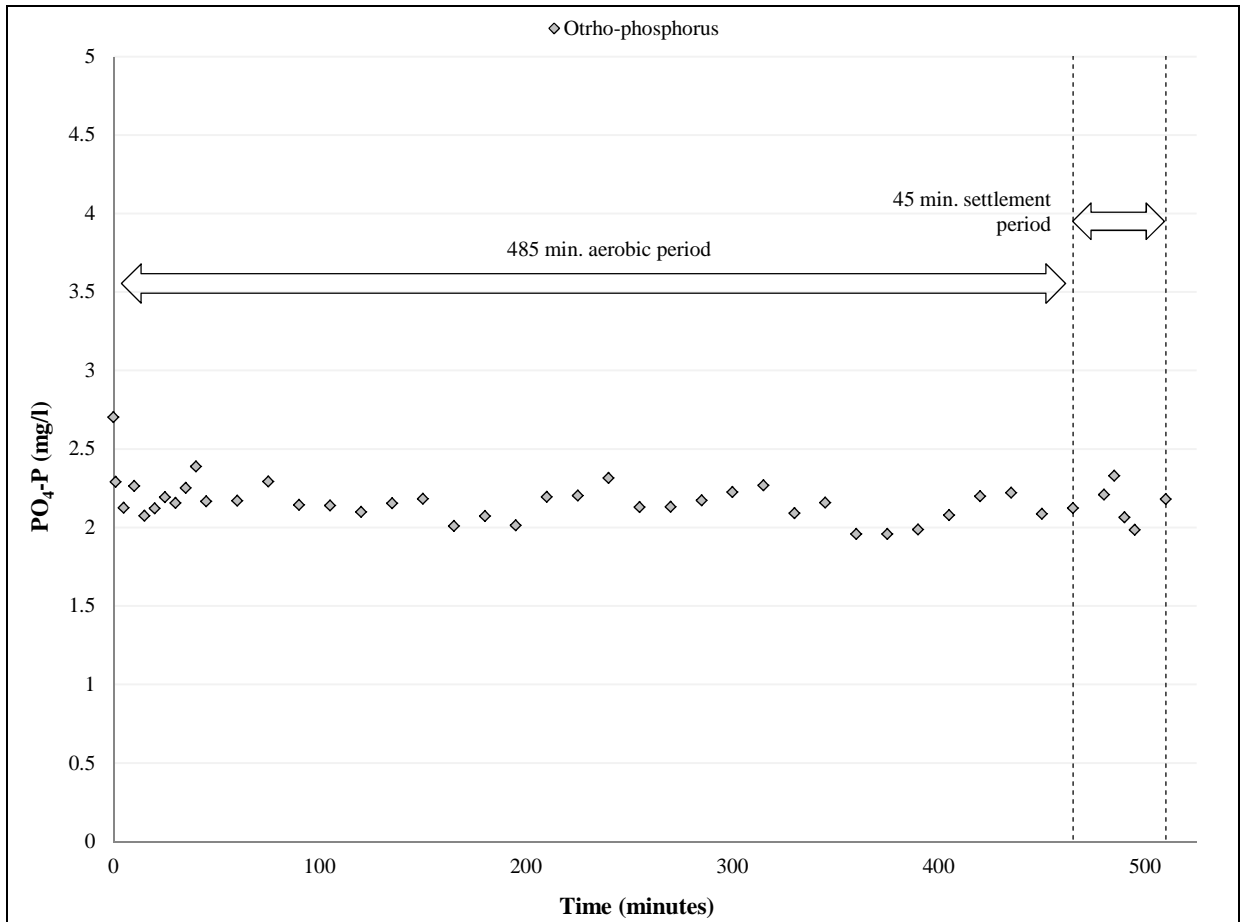

E 2.2.1 Influent wastewater - Study 2 – Phase 2

Date	Day No.	SS mg/l	COD mg/l	COD _f mg/l	TN mg/l	TN _f mg/l	NH ₄ - N mg/l	TON mg/l	NO ₂ - N mg/l	NO ₃ - N mg/l	PO ₄ -P mg/l	Alk mg/l
18/09/12	32.8	45	-	-	21.63	18.83	21.18	1.03	0.02	1.01	0.69	243.78
18/09/12	33.8	275	396	38	21.97	20.09	20.30	6.78	0.29	6.49	0.52	227.23
19/09/12	34.0	108	-	-	23.07	22.06	23.35	2.62	0.04	2.58	0.49	242.86
20/09/12	34.8	100	-	-	21.35	18.85	24.84	0.50	0.02	0.48	0.47	249.14
24/09/12	38.8	275	379	64	18.04	17.52	21.42	1.08	0.01	1.08	0.65	231.45
24/09/12	39	183	-	-	18.21	18.12	19.41	0.10	0.0	0.11	0.79	216.58
25/09/12	35.8	225	-	-	-	-	18.73	0.69	0.01	0.68	1.02	206.41
26/09/12	40.7	193	287	64	16.48	15.72	22.18	0.03	0.02	0.01	1.69	243.78
27/09/12	41.8	95	-	-	20.54	22.37	21.40	0.93	0.05	0.88	0.10	223.73
01/10/12	45.8	78	284	89	26.819	25.61	24.13	0.55	0.25	0.30	1.46	245.87
02/10/12	46.8	293	281	87	29.47	25.87	25.70	0.26	0.01	0.25	1.70	263.92
03/10/12	47.8	273	-	-	28.28	23.53	23.45	0.87	0.15	0.72	0.93	240.76
04/10/12	48.8	208	-	-	25.41	24.81	24.46	0.81	0.07	0.74	1.19	281.18
04/10/12	49.0	220	-	-	24.13	22.72	22.76	0.87	0.08	0.79	1.03	261.55
05/10/12	49.8	270	-	-	23.38	22.67	20.10	0.07	0.02	0.05	0.84	212.12
08/10/12	52.7	395	-	-	27.34	26.02	25.06	0.30	0.21	0.09	0.68	221.62
09/10/12	53.7	148	398	117	44.62	19.30	18.25	0.2	0.16	0.04	0.78	217.73
09/10/12	54.0	60	-	-	17.83	17.42	17.70	0.21	0.02	0.19	0.79	213.59
10/10/12	54.7	128	-	-	22.92	21.18	21.10	0.64	0.04	0.60	1.11	255.54
11/10/12	55.8	138	-	-	23.45	20.96	20.29	2.55	0.49	2.06	0.89	240.70
12/10/12	56.8	100	278	68	27.32	25.15	27.13	0.64	0.52	0.11	1.86	251.87
15/10/12	59.8	200	-	-	26.69	23.97	27.15	0.6	0.23	0.37	1.54	287.33
16/10/12	60.8	183	-	-	26.80	23.17	27.40	0.13	0.01	0.13	1.43	290.83
16/10/12	60.8	233	-	-	28.64	25.92	26.30	0.22	0.05	0.18	1.46	286.44
17/10/12	61.8	128	230	61	26.99	24.61	28.93	0.10	0.1	0.01	0.98	333.66
23/10/12¹	67.8	188	482	111			18.44	2.93	2.16	0.77	0.74	260.21
25/10/12	69.7	250	478	112			21.74	0.14	0.12	0.02	0.67	276.20

E 2.2.1 Influent wastewater - Study 2 – Phase 2 (cont'd)

Date	Day No.	SS mg/l	COD mg/l	COD _f mg/l	TN mg/l	TN _f mg/l	NH ₄ - N mg/l	TON mg/l	NO ₂ - N mg/l	NO ₃ - N mg/l	PO ₄ -P mg/l	Alk mg/l
25/10/12	70.0	233	-	-	22.36	21.44	20.31	0.12	0.11	0.01	0.71	292.30
31/10/12	75.7	438	482	108	21.3	19.52	20.79	0.17	0.12	-0.05	0.49	295.91
01/11/12	77.0	328	468	102	22.02	20.65	18.95	0.07	0.07	0.14	0.71	261.51
06/11/12	81.7	185	498	114	18.37	16.17	15.62	0.30	0.05	0.26	0.88	228.48
06/11/12	82.0	155	-	288	26.96	19.03	19.17	0.25	0.01	0.24	0.24	253.51
09/11/12	85.0	220	710	565	-	-	-	-	-	-	-	-
12/11/12	87.8	353	-	-	18.17	17.49	17.93	0.02	0.06	0.04	0.08	181.03
12/11/12	88.0	228	738	637	-	-	18.93	0.03	0.11	0	0.21	188.03
13/11/12	89.0	310	-	-	14.58	13.78	13.18	0.31	0.29	0.02	0.03	173.63
14/11/12	89.7	318	812	781	14.26	13.97	12.17	0.22	0.19	0.03	0.41	175.36
14/11/12	90.0	195	-	-	13.98	13.13	12.09	0.11	0.03	0.07	0.07	150.40
16/11.12	91.8	160	-	-	13.84	13.50	-	-	-	-	-	-
19/11/12	94.8	200	832	399	14.27	13.55	13.89	0.15	0.02	0.17	0.51	93.45
20/11/12	96.1	200	986	606	13.33	12.95	13.03	0.74	0.44	0.30	3.63	105.45
25/11/12	100.1	178	993	532	13.39	12.60	12.51	0.14	0.03	0.11	0.16	106.36
27/11/12	102.9	190	978	603	16.38	16.19	16.18	0.68	0.45	0.23	0.21	200.41
05/12/12	111.0	105	880	433	20.15	19.84	18.39	0.44	0.15	0.29	1.39	168.61
10/12/12	116.0	113	904	432	22.26	22.19	21.59	0.14	-0.01	0.14	1.25	237.52
12/12/12	118.0	208	-	-	23.30	22.12	22.27	0.15	0.01	0.14	1.78	186.54

E 2.2.2 Effluent wastewater - Study 2 – Phase 2

Date	Day No.	SS mg/l	COD mg/l	COD _f mg/l	TN mg/l	TN _f mg/l	NH ₄ - N mg/l	TON mg/l	NO ₂ - N mg/l	NO ₃ - N mg/l	PO ₄ -P mg/l	Alk mg/l
18/09/12	32.8	132.5	132	35	9.40	7.82	1.26	4.56	0.09	4.47	0.18	101.46
19/09/12	33.2	147.5	-	-	10.61	7.81	2.21	3.85	1.99	1.85	0.26	105.53
19/09/12	33.8	95	117	29	10.96	8.92	1.25	3.70	0.27	3.43	0.22	102.73
20/09/12	34.2	120	-	-	9.99	7.99	0.63	2.33	0.19	2.14	0.22	105.80
20/09/12	34.8	77.5	-	-	10.89	8.41	0.97	3.26	0.75	2.51	0.24	98.29
21/09/12	35.2	102.5	-	-	9.26	6.16	1.07	4.35	0.51	3.84	0.20	95.66
21/09/12	35.9	85	-	-	9.19	8.26	1.11	2.59	0.33	2.26	0.19	98.46
24/09/12	38.1	107.5	-	-	12.34	11.17	0.30	5.77	0.20	5.57	0.35	81.00
24/09/12	38.3	102.5	139	32	12.62	10.11	1.27	5.08	0.36	4.73	0.34	99.65
25/09/12	39.0	92.5	-	-	9.76	8.70	1.20	4.36	0.23	4.13	0.69	80.65
25/09/12	39.1	50	145	33	9.66	8.63	1.20	4.36	0.23	4.13	0.69	80.65
26/09/12	40.0	50	-	-	6.84	6.66	0.69	2.94	0.22	2.72	0.63	88.27
26/09/12	40.1	40	-	-	7.04	5.92	0.86	2.87	0.26	2.61	0.63	92.45
27/09/12	41.0	75	53	45	6.65	6.03	0.79	2.35	0.17	2.18	0.60	94.65
27/09/12	41.1	55	-	-	7.40	6.58	1.20	5.28	0.36	4.93	0.34	97.65
01/10/12	45.3	50	-	-	10.30	8.30	1.90	3.73	0.10	3.63	0.76	102.24
02/10/12	46.1	37.5	72	51	8.65	7.83	0.79	4.10	0.30	3.80	1.18	112.39
02/10/12	46.3	60	-	-	8.39	7.84	0.46	5.00	1.06	3.94	0.72	141.03
03/10/12	47.0	60	-	-	7.42	7.01	1.37	4.49	0.35	4.14	0.73	126.12
03/10/12	47.3	35	-	-	7.87	6.90	0.70	5.91	0.23	5.69	0.78	112.49
03/10/12	47.3	10	-	-	8.17	7.29	2.31	6.39	0.45	5.94	0.89	127.78
04/10/12	48.0	57.5	69	45	10.85	9.77	1.55	7.75	0.31	7.44	0.74	118.97
04/10/12	48.3	7.5	-	-	10.32	9.32	-	-	-	-	-	-
05/10/12	49.0	40	-	-	12.86	11.53	0.65	9.78	0.26	9.52	0.35	116.45
09/10/12	53.0	62.5	-	-	13.08	12.82	0.09	9.72	0.32	9.40	0.40	112.37

E 2.2.2 Effluent wastewater - Study 2 – Phase 2 (cont'd)

Date	Day No.	SS mg/l	COD mg/l	COD _f mg/l	TN mg/l	TN _f mg/l	NH ₄ - N mg/l	TON mg/l	NO ₂ - N mg/l	NO ₃ - N mg/l	PO ₄ -P mg/l	Alk mg/l
10/10/12	54.0	67.5	-	-	13.49	10.38	3.05	6.33	0.31	6.02	0.39	118.10
10/10/12	54.3	20	-	-	13.33	12.07	3.34	6.79	0.55	6.23	0.41	131.83
11/10/12	55.0	52.5	-	-	14.56	10.47	0.73	7.11	0.24	6.87	0.39	110.43
12/10/12	56.0	45	-	-	13.79	10.17	1.44	8.59	0.26	8.33	0.54	126.11
12/10/12	56.2	22.5	37	24	14.49	12.37	0.19	9.03	0.01	9.03	0.56	118.75
15/10/12	59.3	75.0	-	-	14.25	12.73	1.30	9.95	1.49	8.47	0.59	144.78
19/10/12	63.0	20.0	75	46	14.14	12.94	3.30	13.16	2.78	10.38	0.59	185.83
19/10/12	63.1	30.0	-	-	14.08	12.79	3.97	7.91	0.89	7.01	0.43	153.32
22/10/12	66.3	57.5	78	44	10.44	9.39	0.63	7.43	0.33	7.11	0.75	167.40
23/10/12	67.0	55.0	-	-	13.44	11.48	3.46	7.24	1.62	5.62	0.55	175.64
23/10/12	67.1	92.5	76	42	9.46	5.19	0.78	3.71	0.16	3.55	0.45	161.26
24/10/12	68.3	97.5	-	-	10.45	10.03	0.26	2.42	0.74	1.68	0.53	161.06
25/10/12	69.0	100	101	45	11.28	11.14	0.80	6.37	0.23	6.13	0.36	160.19
25/10/12	69.1	115	-	-	12.04	13.27	0.42	2.67	0.01	2.66	0.40	149.32
25/10/12	69.3	107.5	-	-	10.50	10.27	0.68	1.35	0.04	1.31	0.40	158.63
26/10/12	70.0	70.0	121	52	-	-	0.26	2.23	0.15	2.08	0.00	158.20
30/10/12	74.3	80	-	-	15.16	12.04	1.43	2.32	0.13	2.19	0.72	144.21
31/10/12	75.0	125	128	48	14.32	11.16	0.95	2.12	0.30	1.82	0.23	156.91
01/11/12	76.0	97.5	-	-	9.55	8.07	1.09	3.13	1.07	2.06	0.20	164.29
01/11/12	76.1	100	-	-	9.90	9.12	0.87	5.46	1.73	3.73	0.14	176.68
01/11/12	76.3	72.5	134	50	9.34	9.32	2.02	4.30	0.50	3.80	0.17	190.74
02/11/12	77.0	95	-	-	6.45	6.14	1.15	2.48	0.10	2.38	0.14	182.52
05/11/12	80.3	87.5	130	51	9.83	9.92	1.31	6.54	0.19	6.34	0.19	179.87
06/11/12	81.0	105	-	-	6.97	7.84	1.03	4.43	0.10	4.33	0.09	172.62
13/11/12	88.0	117.5	265	54	4.76	3.83	0.18	0.15	0	0.18	0.17	202.02

E 2.2.2 Effluent wastewater - Study 2 – Phase 2 (cont'd)

Date	Day No.	SS mg/l	COD mg/l	COD _f mg/l	TN mg/l	TN _f mg/l	NH ₄ - N mg/l	TON mg/l	NO ₂ - N mg/l	NO ₃ - N mg/l	PO ₄ -P mg/l	Alk mg/l
13/11/12	88.3	115	-	-	3.55	3.47	0.15	0.14	0	0.17	0.17	200.97
13/11/12	88.3	115	-	-	3.55	3.47	0.15	0.14	0	0.17	0.17	200.97
14/11/12	89.2	95	-	-	3.36	3.22	0.10	0.13	0.03	0.16	0.17	190.36
14/11/12	89.3	75	-	-	3.87	3.59	0.05	0.13	0	0.16	0.17	192.26
15/11/12	90.1	120	263	68	4.22	3.37	-	-	-	-	-	-
16/11/12	91.1	100	-	-	22.36	21.44	20.31	0.12	0.11	0.01	0.71	292.30
20/11/12	95.0	95.0	246	91	21.3	19.52	20.79	0.17	0.12	-0.05	0.49	295.91
22/11/12	97.2	117.5	-	-	22.02	20.65	18.95	0.07	0.07	0.14	0.71	261.51
23/11/12	98.1	115	-	-	18.37	16.17	15.62	0.30	0.05	0.26	0.88	228.48
26/11/12	101.0	110	-	-	26.96	19.03	19.17	0.25	0.01	0.24	0.24	253.51
26/11/12	101.3	77.5	275	55	-	-	-	-	-	-	-	-
27/11/12	102.0	62.5	-	-	18.17	17.49	17.93	0.02	0.06	0.04	0.08	181.03
28/11/12	103.0	100	195	53	-	-	18.93	0.03	0.11	0	0.21	188.03
29/11/12	104.0	95.0	154	48	14.58	13.78	13.18	0.31	0.29	0.02	0.03	173.63
30/11/12	105.0	107.5	-	-	14.26	13.97	12.17	0.22	0.19	0.03	0.41	175.36
05/12/12	110.3	90.0	-	-	13.98	13.13	12.09	0.11	0.03	0.07	0.07	150.40
11/12/12	116.0	65.0	209	66	13.84	13.50	-	-	-	-	-	-
11/12/12	116.3	125	-	-	14.27	13.55	13.89	0.15	0.02	0.17	0.51	93.45
12/12/12	117.2	77.5	174	60	13.33	12.95	-	0.74	0.44	0.30	3.63	105.45

E 2.2.3.1 Study 2- Phase 2 a - MWIS 4

	min.	COD mg/l	TN mg/l	TN _f mg/l	NH ₄ -N mg/l	TON mg/l	NO ₂ -N mg/l	NO ₃ -N mg/l	PO ₄ -P mg/l	
90 min. anoxic period	Inf.	0	112	27.72	26.81	22.57	4.75	0.07	4.68	0.86
	1	80			10.21	4.57	0.11	4.47	0.13	
	5		20.77	20.55	9.27	5.77	0.14	5.63	0	
	10	68			8.35	7.62	0.14	7.48	0	
	15		18.67	17.21	7.94	6.02	0.15	5.87	0	
	20	52			7.74	6.02	0.14	5.88	0	
	25		18.23	17.82	7.71	6.67	0.12	6.56	0	
	30				7.80	5.38	0.11	5.26	0	
	35		17.91	17.78	7.76	4.95	0.11	4.84	0	
	40	46			7.91	3.88	0.10	3.77	0	
	45		17.59	17.05	7.95	4.42	0.11	4.32	0	
	50				7.98	4.03	0.11	3.92	0	
	55		17.54	16.63	7.99	3.92	0.09	3.83	0	
	60	42			7.61	3.96	0.09	3.87	0	
	65		17.99	16.61	7.91	3.90	0.08	3.82	0	
	70				8.02	3.84	0.08	3.31	0	
	75		16.93	16.84	7.71	3.39	0.06	3.78	0	
	80				7.81	3.12	0.04	3.08	0	
	85		16.12	15.66	7.80	3.57	0.04	3.53	0	
90	44			7.86	2.73	0.04	2.70	0		
185 min. aerobic period	105		16.20	15.89	8.00	2.70	0.03	2.67	0	
	120				7.71	2.85	0.04	2.81	0	
	135	40	15.95	15.94	7.16	3.13	0.04	3.09	0	
	150				6.89	3.30	0.05	3.25	0	
	165		15.74	15.79	6.28	2.98	0.05	2.93	0	
	180	42			5.81	3.34	0.05	3.29	0	
	195		15.36	15.14	4.91	4.20	0.06	4.14	0	
	210				4.07	4.10	0.06	4.05	0	
	225		15.29	14.82	3.87	4.50	0.06	4.45	0	
	240				3.11	5.31	0.05	5.26	0	
	255	38	14.85	14.61	2.36	5.49	0.04	5.45	0	
S	272				2.10	5.85	0.04	5.81	0	
	282		14.84	14.11	1.94	6.43	0.03	6.4	0	
	292		14.91	14.08	1.86	6.00	0.04	5.97	0	
Eff.	300	42	15.01	14.96	1.94	7.21	0.0	7.17	0	

S - 25 minute settlement period

E 2.2.3.2 Study 2- Phase 2 a - MWIS 4

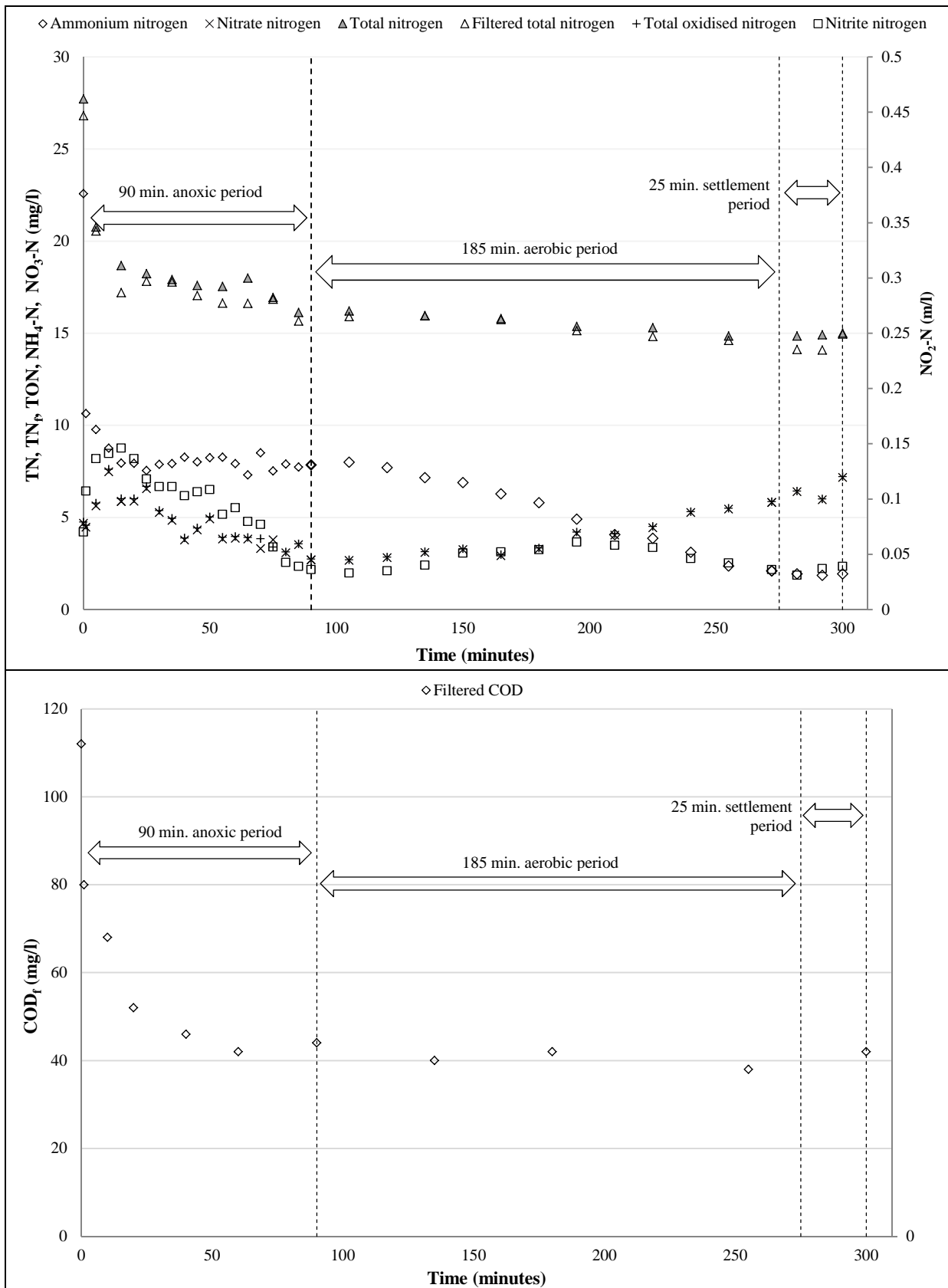

E 2.2.4.1 Study 2- Phase 2 a - MWIS 5

	min.	COD mg/l	TN mg/l	TN _f mg/l	NH ₄ -N mg/l	TON mg/l	NO ₂ -N mg/l	NO ₃ -N mg/l	PO ₄ -P mg/l	Alk mg/l
90 min. anoxic period	0		21.99	20.17	19.76	6.97	0.05	6.91	1.05	204.62
	1				9.10	5.44	0.12	5.32	0.66	170.01
	5		16.35	15.28	8.14	4.91	0.13	4.78	0.38	110.32
	10				7.50	4.87	0.14	4.73	0.84	110.51
	15		16.47	15.03	7.04	4.78	0.14	4.64	0.35	115.85
	20				6.51	4.95	0.13	4.82	0.29	98.92
	25		16.46	14.83	6.31	4.92	0.11	4.81	0.72	98.19
	30				6.56	4.70	0.16	4.54	0.30	97.41
	35		16.09	14.27	6.58	4.59	0.16	4.44	0.29	90.85
	40				6.11	4.54	0.10	4.44	0.28	98.78
	45		16.36	14.78	5.84	4.56	0.09	4.47	0.27	95.06
	50				5.83	4.25	0.09	4.16	0.30	100.68
	55		15.83	13.80	5.29	4.09	0.12	3.97	0.28	96.58
	60				5.37	3.82	0.12	3.69	0.29	100.91
	65		15.52	13.43	5.00	3.67	0.09	3.58	0.27	98.08
	70				4.98	2.94	0.08	2.86	0.30	98.78
	75		15.11	13.22	5.11	2.31	0.08	2.23	0.28	95.29
	80				5.10	2.19	0.03	2.15	0.27	96.80
	85		15.03	13.63	5.02	1.54	0.03	1.51	0.24	91.37
	90				5.02	1.99	0.05	1.94	0.28	91.37
185 min. aerobic period	105		16.03	15.64	4.24	2.57	0.09	2.48	0.34	94.13
	120				3.81	2.97	0.12	2.86	0.33	93.37
	135		16.03	15.64	3.41	3.38	0.16	3.22	0.34	91.57
	150				3.21	3.97	0.21	3.77	0.32	87.82
	165		15.64	15.13	3.38	4.33	0.18	4.15	0.39	86.58
	180				2.04	4.53	0.25	4.28	0.29	89.46
	195		14.49	13.14	1.71	4.73	0.27	4.46	0.29	79.72
	210				1.37	5.42	0.26	5.16	0.28	76.71
	225		14.36	12.82	1.15	5.69	0.26	5.43	0.28	74.52
	240				0.94	6.16	0.23	5.93	0.27	73.06
S	255		14.01	12.64	0.75	6.16	0.21	5.95	0.28	71.20
	272				0.63	6.53	0.18	6.35	0.28	69.22
	282		13.88	12.16	0.50	5.93	0.15	5.78	0.27	67.07
	292		13.50	11.57	0.54	5.56	0.19	5.38	0.28	65.17
Eff.	300		12.94	12.11	0.52	5.94	0.19	5.75	0.28	64.88

S - 25 minute settlement period

E 2.2.4.2 Study 2- Phase 2 a - MWIS 5

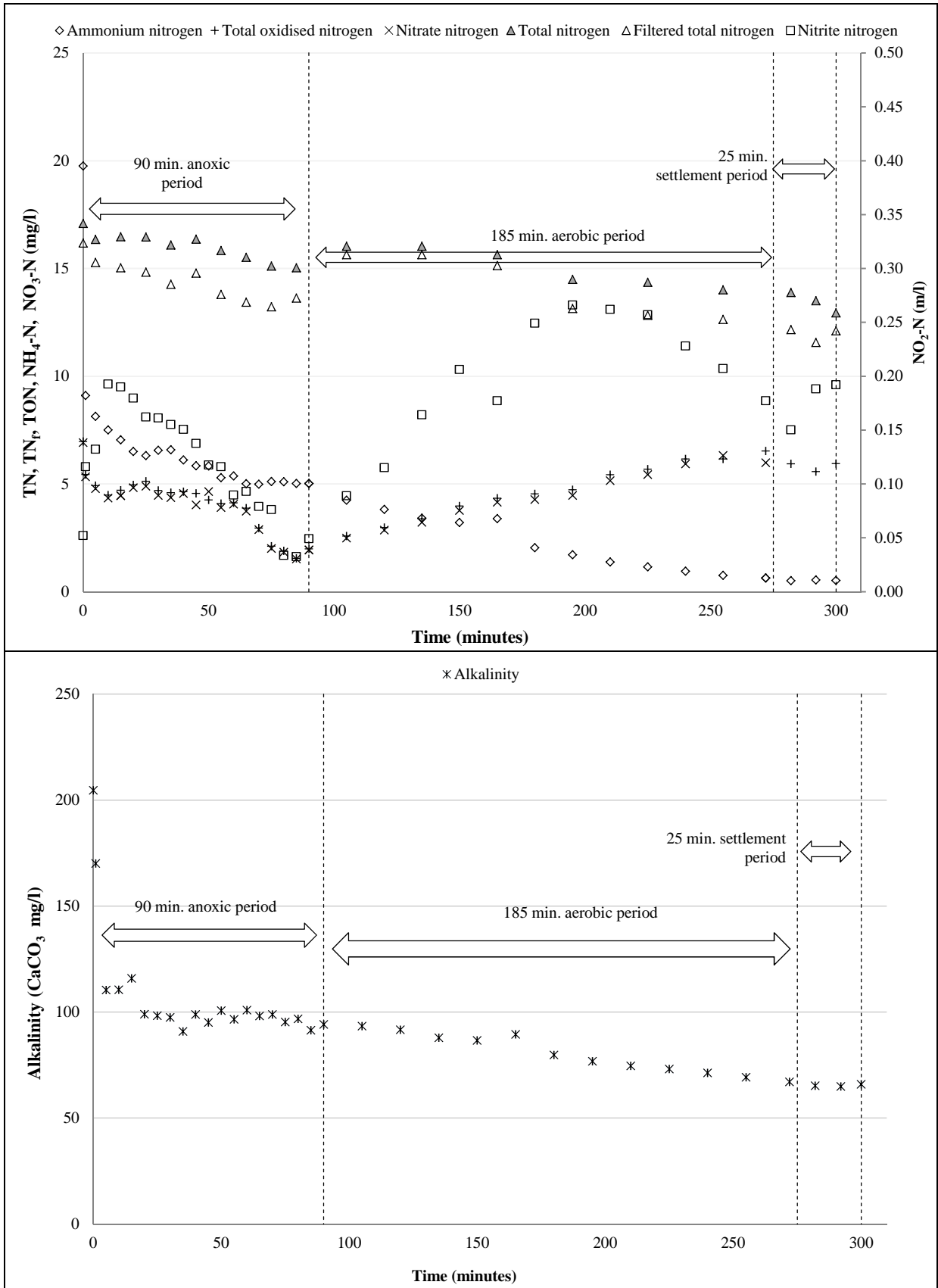

E 2.2.5.1 Study 2- Phase 2 a - MWIS 6

	min.	COD mg/l	TN mg/l	TN _f mg/l	NH ₄ -N mg/l	TON mg/l	NO ₂ -N mg/l	NO ₃ -N mg/l	PO ₄ -P mg/l	Alk mg/l
90 min. anoxic period	0	104	27.75	24.71	24.58	4.37	0.41	3.95	1.09	249.46
	1				13.04	5.17	0.36	4.81	0.70	145.43
	5	74			10.35	5.25	0.28	4.96	0.69	161.68
	10				6.39	5.41	0.17	5.24	0.77	167.98
	15	49	21.71	19.76	6.99	5.37	0.14	5.23	0.71	167.98
	20				7.10	5.20	0.13	5.07	0.70	175.10
	25				6.71	5.04	0.16	4.89	0.77	173.72
	30				6.85	4.96	0.16	4.80	0.71	173.72
	35		20.47	20.34	6.60	4.86	0.15	4.71	0.71	174.53
	40				7.20	4.74	0.14	4.60	0.71	174.53
	45				6.77	4.93	0.13	4.80	0.68	173.13
	50	41			6.28	4.65	0.11	4.54	0.67	174.12
	55		19.30	19.18	6.18	4.73	0.11	4.62	0.69	174.12
	60				6.89	4.69	0.11	4.59	0.70	178.42
	65				6.76	4.55	0.10	4.45	0.70	178.42
	70	37			6.72	4.54	0.10	4.44	0.69	177.12
	75		19.44	18.98	6.69	4.21	0.10	4.11	0.66	177.12
	80				6.43	4.03	0.09	3.94	0.66	172.95
85				6.43	4.31	0.07	4.24	0.64	172.95	
90	38			6.68	3.85	0.09	3.77	0.66	171.62	
185 min. aerobic period	105		19.59	19.12	6.88	5.80	0.13	5.66	0.71	157.62
	120				6.10	6.55	0.22	6.33	0.68	150.79
	135				4.73	6.54	0.26	6.28	0.66	149.67
	150	37			4.16	7.33	0.29	7.04	0.66	145.32
	165		19.55	18.85	4.11	7.56	0.32	7.24	0.66	147.69
	180				3.36	7.95	0.34	7.60	0.64	141.31
	195	36			2.87	8.31	0.35	7.96	0.69	138.67
	210				1.99	8.57	0.33	8.24	0.61	132.75
	225		18.64	18.58	1.66	8.81	0.30	8.51	0.63	129.12
	240				1.19	8.97	0.23	8.73	0.61	127.46
	255	34			0.59	8.16	0.16	8.00	0.67	121.70
	272				1.01	8.91	0.13	8.77	0.60	119.65
S	282		19.37	18.03	0.95	9.25	0.14	9.10	0.61	118.16
	292				0.89	8.74	0.15	8.59	0.37	117.46
Eff.	300	32			0.85	8.81	0.15	8.66	0.37	120.02

S - 25 minute settlement period

E 2.2.5.2 Study 2- Phase 2 a - MWIS 6

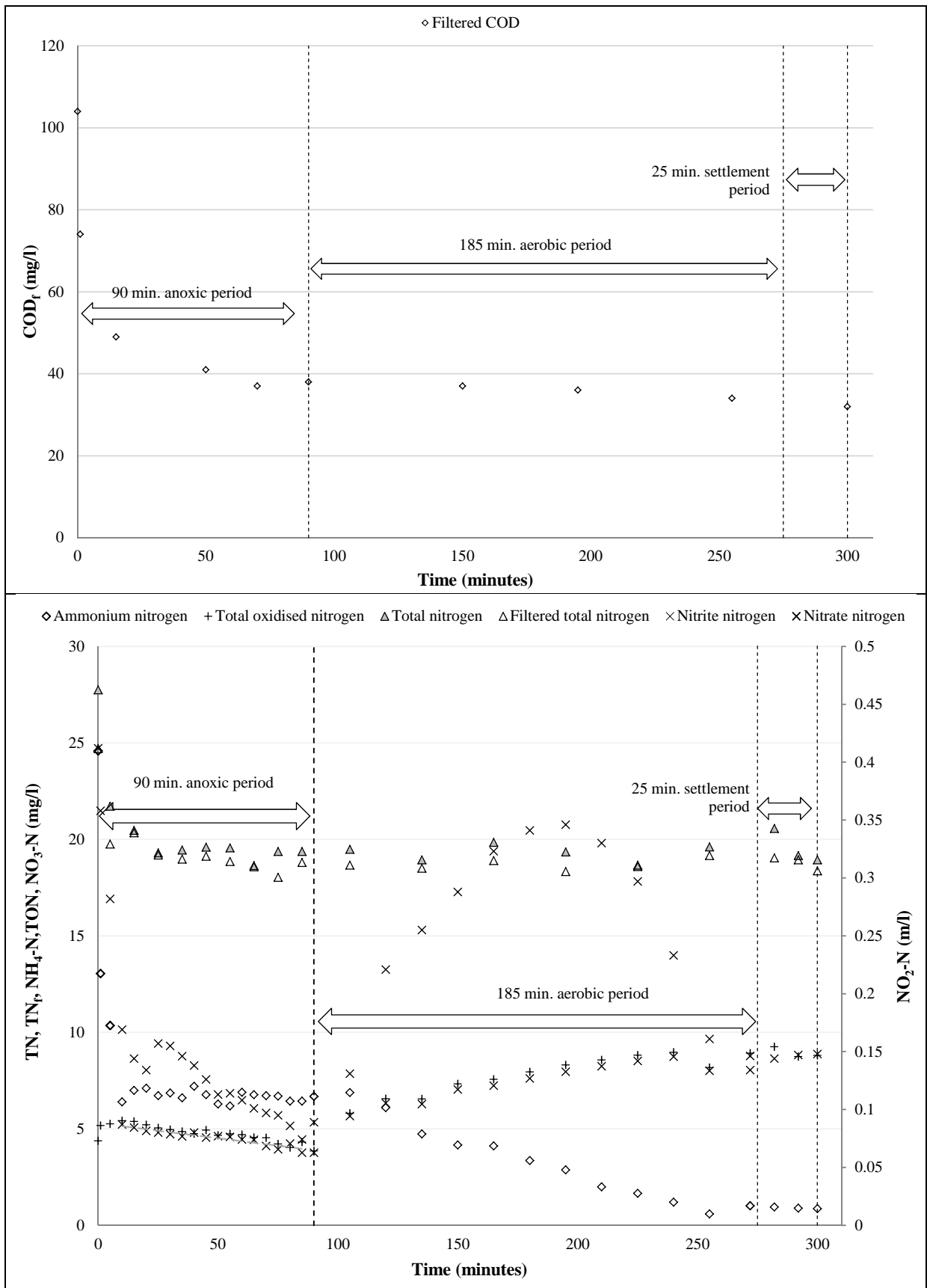

E 2.2.5.2 Study 2- Phase 2 a - MWIS 6 (cont'd)

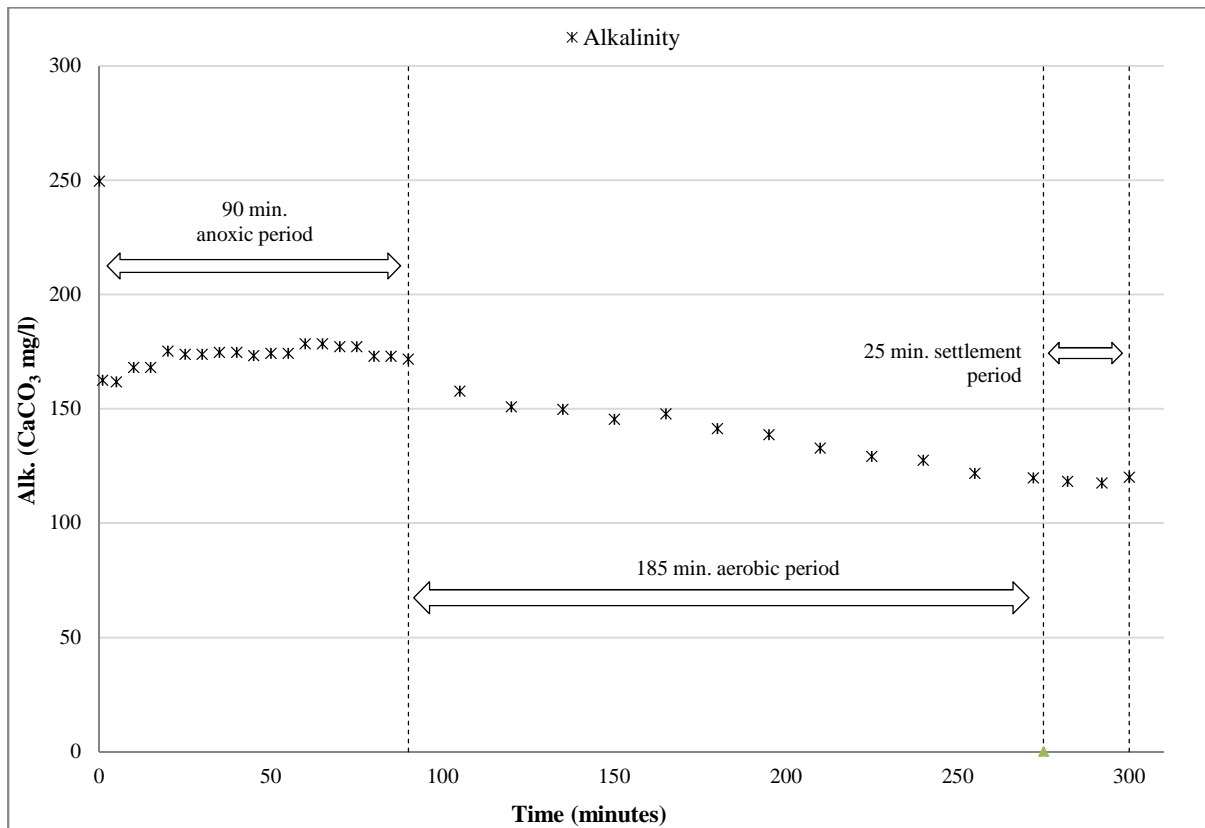

E 2.2.6.1 Study 2- Phase 2 a - MWIS 7

	min.	COD mg/l	TN mg/l	TN _f mg/l	NH ₄ -N mg/l	TON mg/l	NO ₂ -N mg/l	NO ₃ -N mg/l	PO ₄ -P mg/l	Alk mg/l
90 min. anoxic period	Inf.		31.75	26.71	24.95	5.09	3.43	1.67	0.89	244.07
	1				10.72	7.01	4.36	2.65	0.49	176.71
	5		18.12	16.46	9.97	4.56	1.33	3.23	0.49	175.26
	10				7.66	4.51	1.31	3.20	0.48	175.04
	15		13.19	12.95	6.78	4.71	1.20	3.51	0.46	171.21
	20				5.35	4.31	1.23	3.09	0.47	170.57
	25		13.07	12.48	5.40	3.65	1.17	2.48	0.45	167.21
	30				5.28	3.42	0.79	2.63	0.44	166.52
	35		12.44	12.10	5.23	3.38	0.78	2.60	0.50	166.57
	40				4.95	3.25	0.49	2.77	0.50	166.43
	45		12.38	12.38	4.58	3.29	0.53	2.76	0.44	165.18
	50				4.31	3.16	0.37	2.79	0.46	164.90
	55		12.33	12.05	3.91	3.28	0.35	2.93	0.46	165.97
	60				3.18	3.03	0.28	2.74	0.45	165.66
	65		12.13	12.12	2.92	2.97	0.36	2.61	0.44	167.88
	70				2.88	3.02	0.27	2.75	0.44	167.89
	75		13.97	12.07	2.56	3.08	0.34	2.74	0.44	164.35
	80				2.10	3.04	0.24	2.81	0.44	164.04
85		12.89	12.13	1.49	2.94	0.35	2.59	0.44	164.14	
90				1.94	2.63	0.22	2.40	0.51	164.03	
185 min. aerobic period	105		13.43	12.81	2.32	2.48	0.10	2.38	0.57	161.03
	120				2.34	2.39	0.12	2.27	0.57	161.36
	135		13.68	13.10	2.14	2.52	0.14	2.38	0.54	158.49
	150				2.04	2.53	0.15	2.38	0.53	156.99
	165		12.83	12.56	2.04	2.72	0.17	2.55	0.51	155.90
	180				1.90	2.92	0.21	2.71	0.49	153.04
	195		12.34	12.27	1.67	3.16	0.25	2.91	0.48	150.43
	210				1.40	3.32	0.31	3.01	0.49	146.67
	225		13.14	12.27	1.02	3.35	0.30	3.06	0.47	145.39
	240				0.88	3.56	0.31	3.25	0.44	141.43
	255		12.70	12.30	0.71	3.75	0.32	3.42	0.43	137.61
	272		12.39	12.07	0.61	3.74	0.32	3.41	0.44	136.90
S	282		12.41	12.16	0.52	3.70	0.32	3.38	0.43	133.64
	292		14.33	12.45	0.52	3.77	0.36	3.41	0.45	135.07
Eff.	300		12.95	12.53	0.78	3.77	0.32	3.45	0.43	134.08

S - 25 minute settlement period

E 2.2.6.2 Study 2- Phase 2 a - MWIS 7

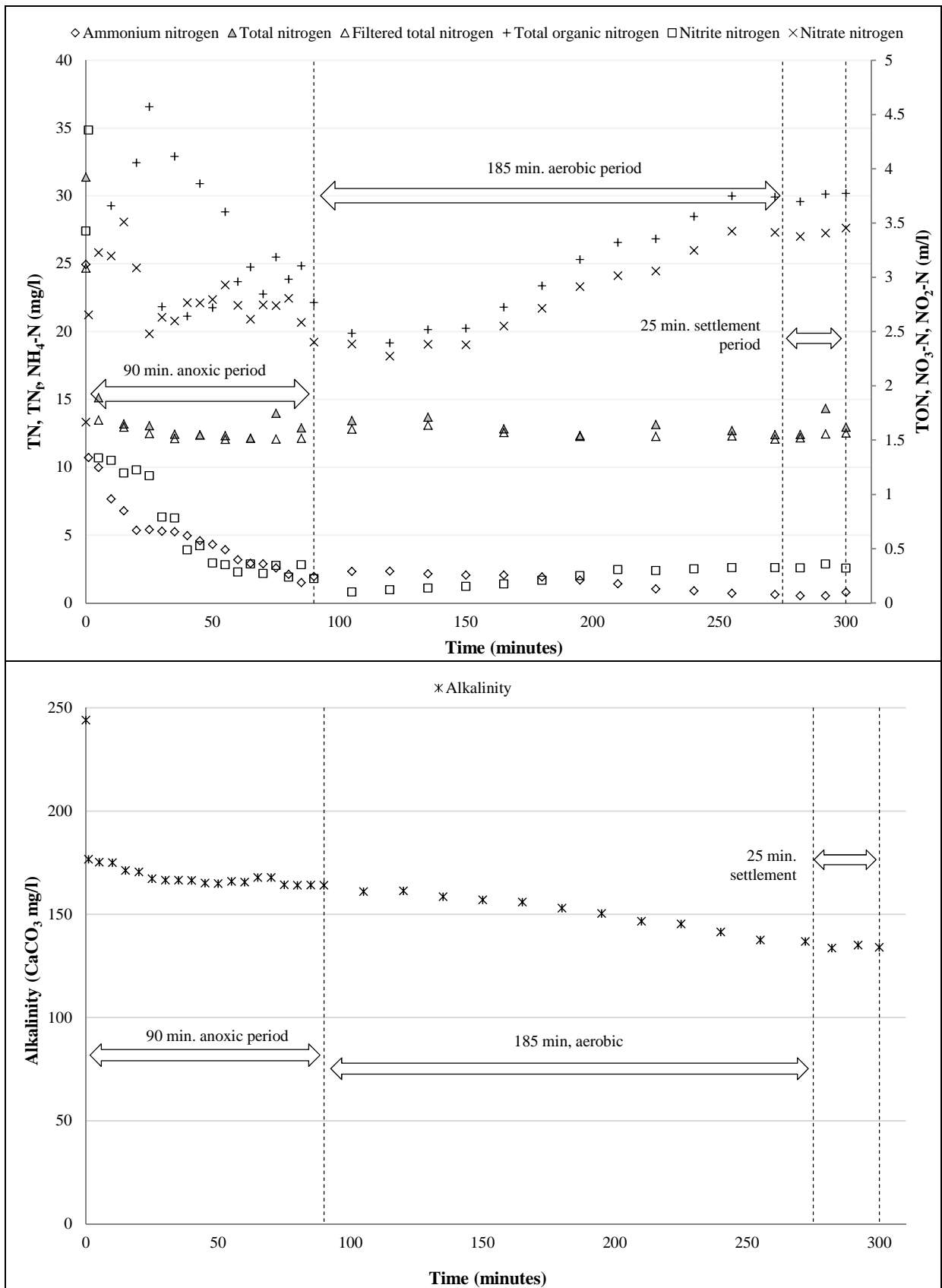

E 2.2.7.1 Study 2- Phase 2 b - MWIS 8

	min.	COD mg/l	TN mg/l	TN _f mg/l	NH ₄ -N mg/l	TON mg/l	NO ₂ -N mg/l	NO ₃ -N mg/l	PO ₄ -P mg/l	Alk mg/l
Inf.	0	534	15.26	13.52	14.81	0.33	0.27	0.07	1.55	112.42
	1		7.94	7.17	4.52	0.37	0.16	0.21	0.47	188.87
	5.	389	7.73	6.46	3.29	0.34	0.14	0.21	0.37	180.55
	10		7.52	5.75	3.26	0.34	0.14	0.20	0.32	180.45
	15				2.31	0.32	0.13	0.19	0.29	179.71
	20	244	6.75	4.78	2.32	0.32	0.13	0.19	0.29	178.35
	25				1.93	0.32	0.14	0.18	0.28	180.58
	30		6.47	5.00	1.86	0.30	0.14	0.17	0.27	182.08
	35				1.72	0.30	0.13	0.17	0.25	184.74
	40	222	5.98	4.77	1.71	0.29	0.13	0.16	0.25	186.24
	45				1.60	0.28	0.13	0.15	0.25	185.88
	50		5.91	4.87	1.52	0.28	0.11	0.16	0.24	187.89
	55				1.73	0.27	0.11	0.16	0.23	188.32
	60	211	6.20	5.22	1.82	0.26	0.10	0.15	0.24	189.15
	65				1.66	0.26	0.10	0.16	0.23	190.88
	70		6.14	4.92	1.64	0.26	0.10	0.16	0.23	188.14
	75				1.91	0.24	0.10	0.15	0.23	186.87
	80		5.68	4.59	1.88	0.24	0.09	0.15	0.28	186.22
	85				1.76	0.23	0.10	0.14	0.28	187.90
	90 min. anoxic period	90	172	5.43	4.75	2.82	0.24	0.09	0.15	0.22
105			5.73	4.92	2.49	0.25	0.08	0.16	0.22	184.76
120		165			2.40	0.26	0.08	0.18	0.25	189.39
135			5.75	4.82	2.25	0.26	0.07	0.18	0.23	194.70
150					1.83	0.27	0.06	0.21	0.23	195.29
165			5.25	4.77	1.62	0.27	0.04	0.23	0.25	198.76
180		163			1.54	0.27	0.03	0.24	0.23	196.87
195			5.17	4.25	1.41	0.28	0.02	0.26	0.22	196.52
210		148			1.29	0.28	0.01	0.27	0.24	199.26
225			4.94	4.25	0.62	0.29	0.01	0.28	0.23	200.82
465 min. aerobic period	240	138			0.10	0.29	0.01	0.28	0.23	200.70
	255		4.60	4.21	0.09	0.29	0.01	0.28	0.23	202.12
	272	139	4.51	4.16	0.05	0.29	0.01	0.27	0.22	198.58
	282		4.48	4.12	0.09	0.29	0.01	0.28	0.23	198.32
	292		4.46	4.08	0.09	0.28	0.02	0.27	0.35	193.90
Eff.	300	140	4.52	4.05	0.09	0.29	0.01	0.28	0.22	196.27

S - 25 minute settlement period

E 2.2.7.2 Study 2- Phase 2 b - MWIS 8

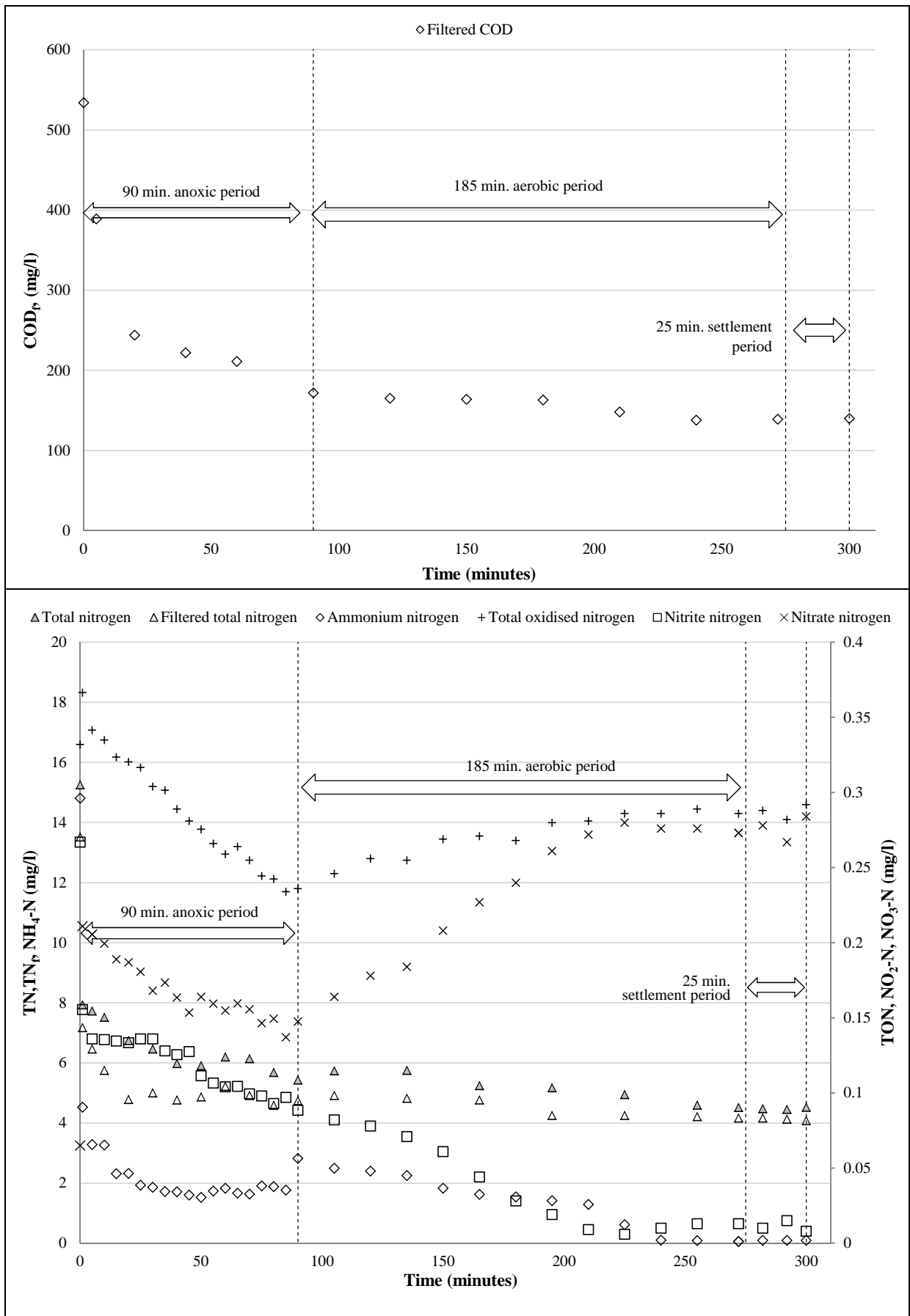

E 2.2.7.2 Study 2- Phase 2 b - MWIS 8 (cont'd)

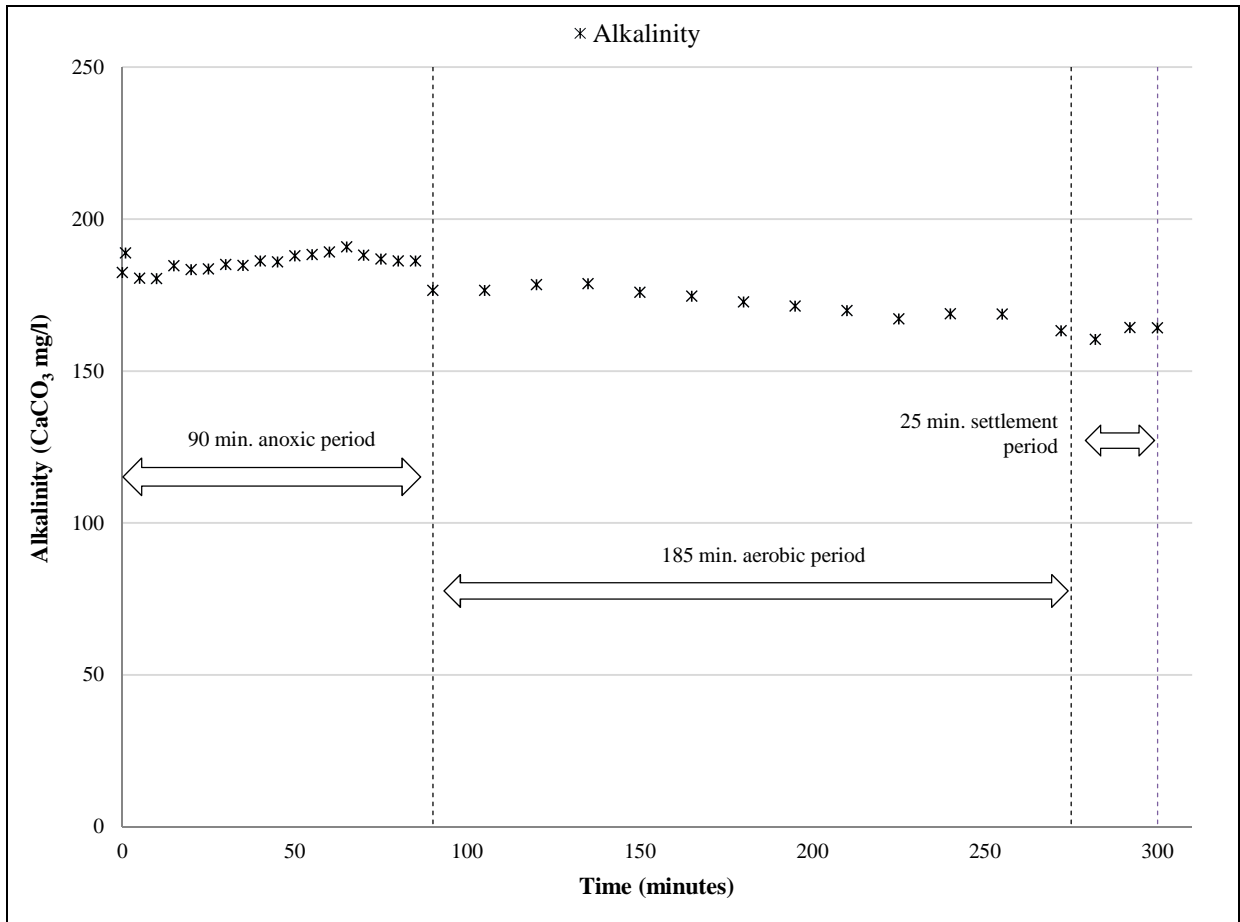

E 2.2.8.1 Study 2- Phase 2 b - MWIS 9

	min.	COD mg/l	TN mg/l	TN _f mg/l	NH ₄ -N mg/l	TON mg/l	NO ₂ -N mg/l	NO ₃ -N mg/l	PO ₄ -P mg/l	Alk mg/l
Inf.	0	688	24.71	18.76	19.49	0.24	0.05	0.20	1.07	180.83
	1		10.16	8.27	6.16	0.33	0.11	0.22	0.56	226.37
	5.	512	9.24	7.84	4.68	0.34	0.11	0.22	0.51	232.27
	10		8.32	7.40	4.51	0.35	0.13	0.22	0.48	232.97
	15	381			4.27	0.35	0.15	0.20	0.46	232.83
		7.93	7.52	4.11	0.34	0.13	0.21	0.46	233.05	233.05
	327			4.13	0.31	0.13	0.18	0.26	231.21	231.21
		7.52	6.90	4.28	0.29	0.12	0.17	0.07	235.93	235.93
	302			4.33	0.28	0.11	0.18	0.06	239.37	239.37
		7.81	7.28	4.41	0.28	0.10	0.18	0.06	239.05	239.05
	273			4.42	0.25	0.10	0.15	0.06	243.39	243.39
		7.78	7.27	4.43	0.24	0.10	0.15	0.06	242.64	242.64
				4.48	0.24	0.09	0.15	0.05	240.28	240.28
		7.37	7.07	4.48	0.23	0.10	0.13	0.04	239.85	239.85
	238			4.17	0.24	0.10	0.14	0.04	245.05	245.05
		7.41	6.82	4.13	0.25	0.10	0.15	0.05	243.71	243.71
				4.18	0.24	0.10	0.14	0.04	242.64	242.64
229	7.14	6.08	4.18	0.24	0.10	0.14	0.08	244.17	244.17	
			3.86	0.23	0.08	0.15	0.09	240.49	240.49	
218	6.46	5.68	4.46	0.21	0.08	0.13	0.04	237.22	237.22	
	6.09	5.95	4.52	0.21	0.09	0.12	0.04	236.97	236.97	
465 min. aerobic period	184	5.67	5.06	4.19	0.21	0.07	0.13	0.04	239.57	239.57
		5.67	4.78	3.27	0.21	0.08	0.13	0.04	242.67	242.67
	174	5.90	5.50	3.15	0.22	0.06	0.16	0.02	241.88	241.88
		5.65	5.32	2.74	0.22	0.05	0.17	0.03	247.32	247.32
	162	5.62	5.49	2.30	0.22	0.03	0.19	0.03	245.61	245.61
		5.23	5.01	2.10	0.23	0.01	0.22	0.02	243.75	243.75
		5.26	5.14	1.65	0.23	0.01	0.22	0.02	243.12	243.12
	154	5.95	5.86	1.64	0.24	0.01	0.23	0.02	245.90	245.90
		5.39	5.05	1.64	0.24	0.00	0.24	0.02	238.96	238.96
		4.93	4.78	0.63	0.24	0.00	0.24	0.02	244.59	244.59
S	150	4.81	4.78	0.68	0.25	0.02	0.23	0.01	248.22	248.22
	146	5.36	5.16	0.62	0.25	0.01	0.24	0.39	247.96	247.96
		5.55	5.00	0.69	0.24	0.01	0.23	0.02	251.49	251.49
Eff.	144	5.72	5.48	0.78	0.25	0.02	0.22	0.02	249.82	249.82

S - 25 minute settlement period

E 2.2.8.2 Study 2 - Phase 2 b - MWIS 9

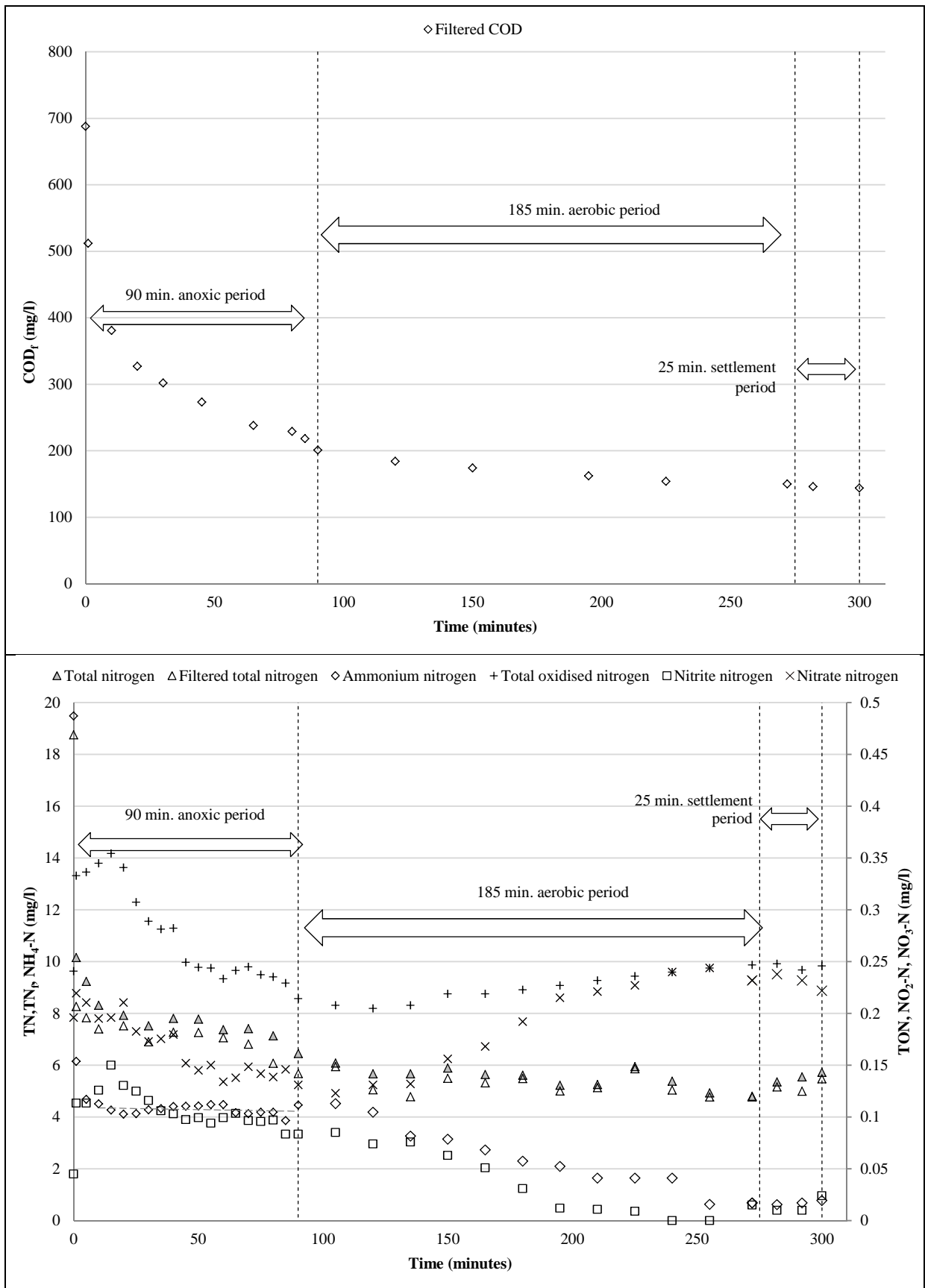

E 2.2.8.2 Study 2- Phase 2 b - MWIS 9 (cont'd)

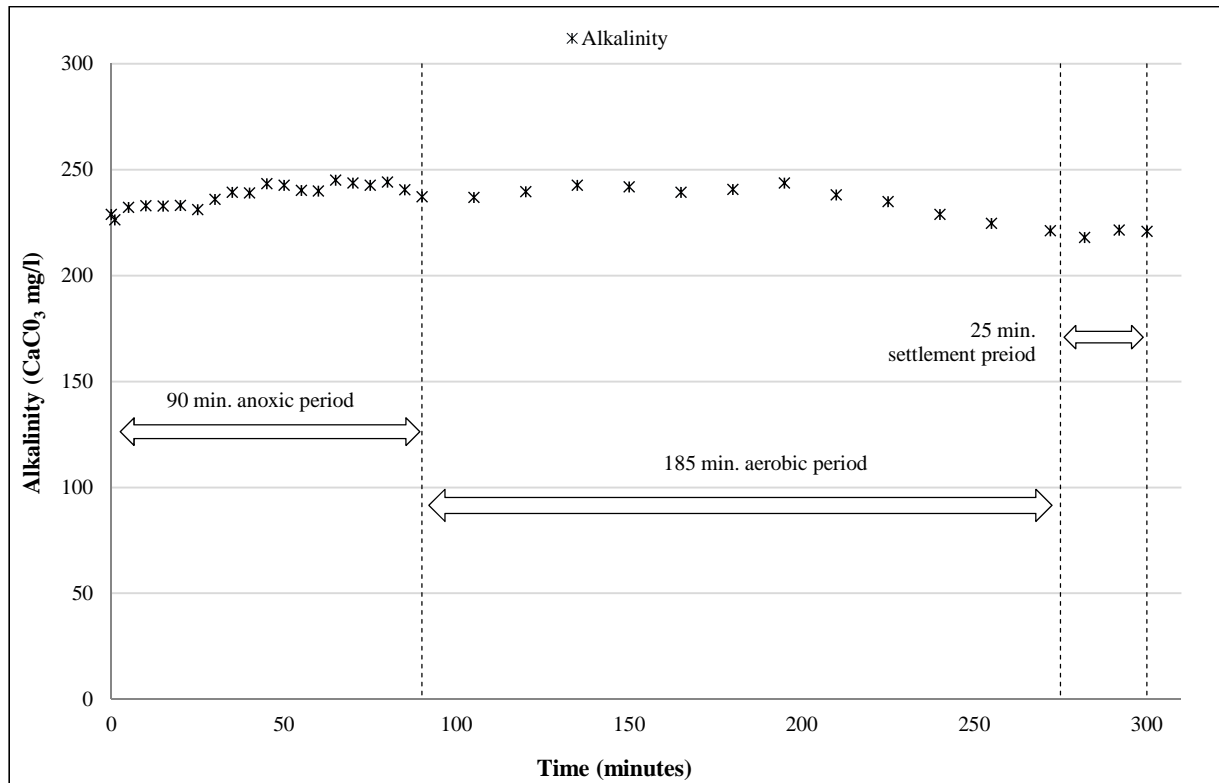

APPENDIX F

Landfill leachate result

F 3.1.1 Influent landfill leachate - Study 3 - Phase 1

Date	Day No.	SS	COD	COD _f	TN	TN _f	NH ₄ -N	TON	NO ₂ -N	NO ₃ -N	PO ₄ -P	Alk
		mg/l	mg/l	mg/l	mg/l	mg/l	mg/l	mg/l	mg/l	mg/l	mg/l	mg/l
05/01/12	14.8	150	2182	1922	1151.6	1124.9	1137.6	0	0	0	3.9	-
09/01/12	18.7	235	2204	1844	1114.8	1092.3	958.1	1.5	0.6	0.8	3.1	-
12/01/12	21.7	235	-	-	1016.9	1119.3	1019.4	0.2	0.13	0.0	3.5	-
16/01/12	25.7	335	1948	1464	1114.3	1092.8	912.2	0.9	0.6	0.2	2.4	-
17/01/12	26.7	255	-	-	1108.8	1062.3	1020.0	2.1	0.1	1.9	2.9	-
18/01/12	27.7	235	1918	1672	1093.1	1076.0	1050.5	0.5	0.0	0.5	5.9	-
19/01/12	28.7	142	2138	1822	1091.4	1074.5	1042.6	1.3	0.7	0.6	3.1	-
23/01/12	32.7	180	1838	1642	1154.7	1143.9	959.3	0.2	0.1	0.1	3.3	-
24/01/12	33.8	58	1838	1686	1211.8	1124.9	957.3	0.1	0.1	0.0	4.1	-
25/01/12	34.9	78	1818	1566	1247.8	1167.7	890.3	0.6	0.1	0.5	4.2	-
09/02/12	49.9	115	2320	2084	1367.2	1216.6	881.1	0	0.1	0.1	1.1	-
10/02/12	50.8	187	2370	1966	1286.6	1184.3	888.9	0.0	0.1	0	0.8	-
14/02/12	54.7	110	2138	1530	1242.7	1132.9	824.7	1.0	0.4	0.6	1.7	-
15/02/12	55.9	88	-	-	1226.2	1130.5	990.3	0.1	0.2	0	5.3	-
16/02/12	56.7	177	2372	1912	1387.7	1271.1	1020.4	0.5	0.0	0.5	7.2	-
20/02/12	60.8	133	-	-	1227.8	1219.7	1252.8	0.2	0.2	0.0	3.6	-
23/02/12	63.9	223	2218	1880	1166.4	1109.0	1355.3	0.2	0.2	0.0	3.8	-
24/02/12	64.8	47	-	-	1215.8	1123.5	1362.2	0.4	0.4	0.0	4.1	-
28/02/12	68.8	240	1810	1464	1205.3	1187.8	1265.6	0.2	0.2	0.0	4.0	-
05/03/12	74.9	210	2018	1644	1354.7	1043.5	1321.8	0.2	0.2	0.1	5.7	3903.6
12/03/12	81.7	143.3	1988	1654	1232.8	1147.7	1339.7	0.9	0.2	0.7	6.4	4103.6
02/04/12	102.9	93	1866	1710	1385.7	1063.5	1362.8	0.0	0.0	0.0	8.3	3867.5
12/04/12	112.9	98	-	-	1393.9	1352.5	1363.3	0	0	0	8.3	4001.1
13/04/12	113.6	73	1956	1672	1342.7	12.6	1319.1	0	0.7	0	6.7	3801.2
19/04/12	119.6	73	-	-	1389.6	1331.5	1309.4	0	0	0	7.5	4306.8
20/04/12	120.7	308	-	-	877.5	848.9	1225.5	0.2	0.5	0	6.4	4764.5
23/04/12	123.7	55	1790	1634	821.2	805.5	1325.5	0.4	0.7	0	7.2	5295.5

F 3.1.1 Influent landfill leachate - Study 3 - Phase 1 (cont'd)

Date	Day No.	SS	COD	COD _f	TN	TN _f	NH ₄ -N	TON	NO ₂ -N	NO ₃ -N	PO ₄ -P	Alk
		mg/l	mg/l	mg/l	mg/l	mg/l	mg/l	mg/l	mg/l	mg/l	mg/l	mg/l
24/04/12	124.7	68	1822	1660	1486.4	1447.4	1325.5	-0.3	0.1	0	6.8	5313.8
27/04/12	127.7	145	-	-	-	-	1358.5	0.9	1.2	0	6.2	6440.8
30/04/12	130.7	90	1808	1670	1428.4	1418.1	1403.6	0.0	0.3	0	7.2	5546.8
02/05/12	132.7	65	1390	1280	1421.1	1390.9	1276.6	0.0	0.1	0	6.4	5203.4
03/05/12	133.9	60	1574	1288	1432.3	1385.1	1351.8	1.4	1.4	0.0	6.9	5404.0
04/05/12	137.7	55	-	-	1229.0	1188.8	1152.3	1.0	0.8	0.2	7.3	5829.2
08/05/12	138.7	60	1438	1308	1219.5	1171.0	1152.3	1.0	0.5	0.5	7.0	5748.1
10/05/12	141.1	53	-	-	1295.9	1216.7	1120.1	5.7	1.0	4.7	2.9	5558.4
14/05/12	144.8	57	877	765	1365.4	1310.7	1297.8	0.0	0.2	0	2.7	5208.3
21/05/12	151.7	61	-	-	1180.5	1087.7	1074.3	1.2	4.3	0	2.9	5412.5
23/05/12	153.7	88	875	799	1160.3	1081.4	1051.2	2.2	1.1	1.0	2.6	5315.2
24/05/12	154.8	93	907	797	1444.3	1417.1	1251.4	1.9	0.3	1.6	2.6	5024.4
25/05/12	155.7	103	681	631	1312.1	1223.2	1117.1	1.2	0.4	0.8	1.7	5284.2
29/05/12	159.9	125	842	774	1395.4	1385.5	1302.8	0.1	1.0	0	3.2	5356.6
30/05/12	160.9	120	872	765	1583.3	1456.3	1325.1	2.0	5.9	0	3.3	5616.5
05/06/12	166.7	95	-	-	1396.6	1334.8	1227.0	3.2	1.4	1.7	2.8	5423.1
06/06/12	167.7	105	-	-	-	-	1114.3	4.7	0.7	8.2	3.5	5712.2
07/06/12	168.7	105	-	-	-	-	1139.3	1.7	6.5	8.2	11.4	5823.6
08/06/12	169.7	120	-	-	1204.6	1159.7	1081.7	8.6	3.6	5.1	10.7	5523.2
11/06/12	172.7	120	-	-	1441.1	1197.7	1014.3	0.2	0.1	0.1	11.6	-
12/06/12	173.7	118	-	-	1276.2	1147.6	1056.7	8.6	2.4	6.2	10.1	-
13/06/12	175.0	128	-	-	1188.7	1164.1	1070.6	0.4	0.1	0.3	11.1	-
14/06/12	175.7	77	-	-	1298.0	1257.8	1101.6	0.8	0.1	0.7	11.0	-
15/06/12	176.7	133	-	-	1207.5	1188.6	1052.6	1.5	5.2	9.4	11.0	-
18/06/12	179.7	140	-	-	1277.6	1205.5	1048.1	0.5	0.1	0.4	11.2	-
19/06/12	180.7	133	1910	1640	1274.3	1217.8	1066.2	7.9	3.4	4.6	11.0	-
20/06/12	181.7	130	-	-	1193.7	1088.2	1005.9	2.5	0.3	2.2	9.6	-

F 3.1.1 Influent wastewater - Study 3 - Phase 1 (cont'd)

Date	Day No.	SS	COD	COD _f	TN	TN _f	NH ₄ -N	TON	NO ₂ -N	NO ₃ -N	PO ₄ -P	Alk
		mg/l	mg/l	mg/l	mg/l	mg/l	mg/l	mg/l	mg/l	mg/l	mg/l	mg/l
21/06/12	182.9	118	1914	1662	1090.7	1072.6	1050.2	2.1	0.2	2.2	8.8	
25/06/12	188.7	153	-	-	-	-	1027.1	2.5	0.9	1.6	8.6	4043.7
28/06/12	189.8	25	1868	1708	1082.9	1011.6	1027.0	3.9	0	3.9	8.4	3747.5
02/07/12	193.7	85	1852	1692	1091.7	1059.0	1127.0	0	0	0	9.9	3767.0
16/07/12	207.8	75	-	-	1470.7	1393.2	1270.7	0.7	0	0.7	6.9	6345.5
18/07/12	209.9	135	-	-	1467.4	1380.7	1353.6	3.1	1.2	1.9	5.5	6316.8
23/07/12	214.8	60	1644	1472	1398.9	1365.7	1254.2	0.5	0.0	0.5	6.4	5796.8
24/07/12	215.8	100			1317.5	1294.6	1320.8	5.2	2.1	3.0	6.0	5965.5
25/07/12	216.7	115	1670	1506	1413.9	1371.6	1351.6	6.8	2.9	3.9	6.1	6212.6
31/07/12	222.7	450	-	-	1717.1	1682.2	1569.4	9.3	4.2	5.1	5.3	6797.4
01/08/12	223.7	400	-	-	1663.3	1637.1	1669.4	9.3	4.2	5.1	5.3	6797.4
02/08/12	224.7	198	-	-	1444.3	1419.2	1385.7	6.4	2.6	3.7	5.5	5177.3
10/08/12	232.7	270	-	-	1393.6	1356.6	1327.7	8.4	3.3	5.1	5.1	3892.8
13/08/12	235.7	253	1810	1566	1439.9	1389.2	1317.8	4.2	1.8	2.5	4.9	4024.2
16/08/12	239.0	380	-	-	-	-	1273.3	4.4	1.5	2.8	5.7	
20/08/12	242.7	310	1993	1580	1371.1	1335.5	1006.4	3.2	1.0	2.1	5.6	5147.3
23/08/12	245.7	253			1383.1	1255.8	1092.2	15.2	12.2	3.1	5.8	5796.8
24/08/12	246.7	448	1935	1502	1394.0	1212.9	875.6	32.1	20.4	11.8	5.2	4924.1
29/08/12	252.0	382	-	-	1333.3	1296.3	891.7	32.8	22.0	10.8	5.8	5117.2

F 3.1.2 Effluent wastewater - Study 3 - Phase 1

Date	Day No.	SS	COD	COD _f	TN	TN _f	NH ₄ -N	TON	NO ₂ -N	NO ₃ -N	PO ₄ -P	Alk
		mg/l	mg/l	mg/l	mg/l	mg/l	mg/l	mg/l	mg/l	mg/l	mg/l	mg/l
05/01/12	15.0	80	502	466	-	-	44.4	537.0	0.7	536.3	0.5	-
09/01/12	19.0	50	700	550	367.8	360.9	81.9	544.6	1.8	542.7	0.8	-
12/01/12	21.7	125	806	664	390.3	377.3	200.4	533.0	3.0	530.0	3.4	-
12/01/12	22.0	130	-	-	396.4	373.3	79.0	552.8	3.4	549.4	1.0	-
13/01/12	22.7	120	-	-	415.5	397.1	105.5	593.4	4.4	589.0	1.0	-
16/01/12	25.9	110	-	-	419.6	398.1	-	-	-	-	-	-
17/01/12	26.7	145	356	258	439.1	424.3	68.0	593.8	4.4	589.4	1.4	-
18/01/12	27.7	110	-	-	415.5	409.1	83.0	629.1	4.6	624.5	1.7	-
19/01/12	28.7	185	-	-	434.0	422.9	90.1	628.6	5.1	623.5	2.3	-
19/01/12	29.0	158	-	-	437.8	431.9	104.0	647.5	4.0	643.6	1.1	-
20/01/12	29.7	126	516	436	436.0	430.6	99.8	677.0	5.3	671.6	1.1	-
20/01/12	29.9	148			435.7	425.7	99.6	613.4	6.4	607.1	1.5	-
23/01/12	33.0	124	640	522	451.5	446.7	86.0	580.2	0.5	579.6	9.0	-
24/01/12	33.8	134	-	-	426.7	390.3	260.3	634.5	2.3	632.2	0.1	-
25/01/12	34.9	77	620	420	539.6	502.9	134.5	645.6	2.9	642.6	0.8	-
26/01/12	35.9	70	-	-	-	-	99.9	575.6	2.6	572.9	4.5	-
26/01/12	36.0	135	-	-	579.4	547.3	90.3	612.6	0.4	612.3	8.1	-
09/02/12	49.7	194	-	-	545.1	556.1	86.2	595.7	2.1	593.6	2.3	-
09/02/12	49.9	197	-	-	651.5	584.0	125.9	725.8	2.0	723.8	0.9	-
10/02/12	50.8	207	-	-	565.2	563.0	116.4	716.3	2.1	714.2	0.8	-
14/02/12	54.7	110	-	-	550.2	613.7	107.5	740.4	0.8	739.6	3.2	-
15/02/12	55.9	200	-	-	595.6	585.3	134.7	733.9	1.4	732.6	1.5	-
15/02/12	56.0	125	-	-	672.8	663.5	101.7	618.7	3.6	615.1	2.2	-
16/02/12	56.7	167	-	-	570.3	560.2	123.5	515.1	1.3	513.8	2.1	-
17/02/12	57.8	240	600	466	558.1	513.0	128.5	514.9	1.9	513.1	2.1	-
20/02/12	60.8	160	-	-	670.0	632.6	133.6	513.1	1.2	511.8	0.9	-
23/02/12	63.9	173	569	488	709.2	632.2	144.3	617.0	2.4	614.7	1.1	-

F 3.1.2 Effluent wastewater - Study 3 - Phase 1 (cont'd)

Date	Day No.	SS	COD	COD _f	TN	TN _f	NH ₄ -N	TON	NO ₂ -N	NO ₃ -N	PO ₄ -P	Alk
		mg/l	mg/l	mg/l	mg/l	mg/l	mg/l	mg/l	mg/l	mg/l	mg/l	mg/l
24/02/12	64.8	100	672	574	611.3	581.4	-	-	-	-	-	-
28/02/12	68.8	167	586	348	620.2	540.1	-	-	-	-	--	-
29/02/12	70.0	167	656	396	564.7	615.2	119.8	548.0	1.3	546.7	0.9	-
02/03/12	71.8	157	662	372	-	-	106.0	538.6	1.0	538.6	1.1	-
02/03/12	72.1	167	506	326	-	-	116.9	556.3	1.2	555.1	3.2	-
05/03/12	75.1	170	486	374	-	-	140.7	565.0	2.2	562.8	1.1	-
06/03/12	75.8	153	434	384	-	-	113.0	514.0	1.2	512.8	0.9	-
06/03/12	75.8	70	458	402	-	-	119.3	514.4	0.9	513.6	0.8	-
12/03/12	81.8	67	-	-	-	-	286.3	513.7	3.3	510.4	1.1	-
13/03/12	82.9	163	622	412	-	-	291.1	513.0	3.3	510.7	1.2	-
16/03/12	86.0	170	664	438	713.4	685.9	135.3	556.9	6.7	550.2	1.3	-
04/04/12	104.7	183	630	466			189.7	604.9	11.4	593.5	1.2	73.1
13/04/12	113.7	185	-	-	664.2	660.3	92.8	600.1	0.9	598.8	0.9	77.1
17/04/12	117.7	248	-	-	671.7	663.0	62.6	499.7	8.1	491.2	0.9	46.5
17/04/12	118.0	190	-	-	661.6	622.0	75.6	587.9	12.3	575.6	0.9	51.4
18/04/12	118.7	145	628	328	670.1	665.2	85.2	574.7	4.9	569.8	1.5	63.6
19/04/12	119.7	193	-	-	677.1	640.2	91.5	582.4	2.6	579.8	0.9	51.1
19/04/12	120.0	168	-	-	-	-	101.0	525.1	1.8	523.3	0	70.1
20/04/12	120.7	138	682	460	694.3	690.6	103.9	514.9	1.5	513.4	0.7	60.9
24/04/12	124.7	253	774	532	930.6	912.1	123.6	791.3	0.3	811.0	0.1	53.2
24/04/12	125.0	240	-	-	731.1	717.6	120.6	633.1	0.3	632.7	0.2	64.8
25/04/12	125.7	223	-	-	836.3	780.1	112.8	704.1	0.9	703.2	0.3	45.8
25/04/12	126.0	153	588	506	926.8	822.9	104.1	656.6	5.6	651.0	0.3	33.9
27/04/12	127.7	223	-	-	747.9	717.1	91.7	653.1	2.5	650.6	0.2	48.0
30/04/12	131.0	150	-	-	748.8	715.0	123.6	810.4	2.0	808.4	0.5	62.7
01/05/12	131.7	178	-	-	753.9	723.3	131.0	792.5	1.2	791.3	0.0	50.8
01/05/12	132.0	130	-	-	752.7	713.0	132.1	855.5	0.7	854.8	0.0	55.8

F 3.1.2 Effluent wastewater - Study 3 - Phase 1 (cont'd)

Date	Day No.	SS	COD	COD _f	TN	TN _f	NH ₄ -N	TON	NO ₂ -N	NO ₃ -N	PO ₄ -P	Alk
		mg/l	mg/l	mg/l	mg/l	mg/l	mg/l	mg/l	mg/l	mg/l	mg/l	mg/l
02/05/12	132.7	153	784	676	761.9	756.6	138.8	768.6	0.6	767.9	0.7	73.9
03/05/12	133.7	180	-	-	-	-	132.3	823.6	0.7	822.9	0.0	55.3
03/05/12	134.0	210	636	426	891.2	816.5	114.1	847.7	0.4	847.3	0.1	53.7
04/05/12	134.7	248	624	450	-	-	171.3	765.5	0.5	765.0	0.0	253.7
04/05/12	134.9	295	-	-	-	-	118.1	897.0	1.3	895.7	0.7	76.3
09/05/12	139.7	110	-	-	790.9	748.5	134.4	770.4	2.2	768.2	0.3	80.6
10/05/12	140.7	228	642	480	780.7	753.5	-	-	-	-	-	-
10/05/12	141.0	220	-	-	793.3	736.0	-	-	-	-	-	-
11/05/12	141.7	170	-	-	788.7	762.5	-	-	-	-	-	-
11/05/12	142.0	158	-	-	890.8	851.6	139.1	760.6	0.6	760.1	0.0	60.0
16/05/12	146.7	183	-	-	878.4	868.7	129.7	785.2	1.6	783.6	0.4	57.3
16/05/12	147.0	195	482	251	789.4	763.7	128.9	824.3	1.3	823.0	0.5	56.7
22/05/12	152.7	198	-	-	874.2	838.8	160.1	678.7	7.8	670.9	0.7	149.7
22/05/12	152.8	208	-	-	768.5	744.7	169.9	763.4	5.1	758.3	0.5	150.9
23/05/12	153.7	190	-	-	779.5	765.6	180.0	632.6	4.4	628.2	0.2	159.6
23/05/12	154.0	213	490	358	837.7	823.2	173.5	670.7	3.1	667.6	0.6	164.0
24/05/12	154.7	102	-	-	783.2	755.7	179.2	654.5	3.3	651.2	0	148.8
24/05/12	155.0	223	-	-	913.5	891.9	119.3	670.6	3.4	667.2	0.0	102.8
25/05/12	155.7	133	579	328	815.6	805.7	111.5	706.2	2.5	703.7	0	71.2
28/05/12	158.7	128	424	266	777.8	766.4	104.4	864.9	3.9	861.0	0.5	72.3
28/05/12	158.9	110	-	-	1175.1	1075.3	114.2	933.8	0.3	933.5	1.0	65.6
29/05/12	159.7	138	-	-	997.0	972.9	105.8	838.2	0.1	838.1	1.5	78.9
30/05/12	160.7	158	-	-	934.6	924.4	134.5	779.0	0.1	778.9	1.2	81.7
30/05/12	160.9	180	352	267	897.0	886.8	125.5	749.2	0.3	748.9	1.5	76.5
31/05/12	161.7	283	-	-	842.2	798.7	117.0	685.8	0.1	685.7	0.0	84.3
01/06/12	162.7	213	450	267	935.7	903.9	112.6	785.5	0.1	785.4	0.2	75.4
05/06/12	167.0	218	-	-	882.4	848.1	118.8	720.0	0.8	719.2	-0.1	73.5

F 3.1.2 Effluent wastewater - Study 3 - Phase 1 (cont'd)

Date	Day No.	SS	COD	COD _f	TN	TN _f	NH ₄ -N	TON	NO ₂ -N	NO ₃ -N	PO ₄ -P	Alk
		mg/l	mg/l	mg/l	mg/l	mg/l	mg/l	mg/l	mg/l	mg/l	mg/l	mg/l
06/06/12	167.7	173	-	-	996.8	983.0	116.2	868.7	0.3	868.4	0.6	74.1
06/06/12	168.0	208	-	-	-	-	129.6	797.6	0.0	797.6	1.8	51.9
07/06/12	168.7	175	1092	576	-	-	181.3	931.3	0.1	931.2	1.4	-
07/06/12	169.0	200	-	-	1382.8	1362.2	189.6	989.8	0.1	989.7	0.2	-
08/06/12	169.7	195	-	-	1393.2	1379.9	188.2	904.0	0.1	904.0	0.1	-
11/06/12	172.9	213			1370.8	1369.2	186.2	955.7	0.1	955.6	0.3	-
12/06/12	173.7	193	1094	538	1208.8	1382.4	189.3	928.5	0.0	928.5	0.7	-
12/06/12	173.9	185	980	542	1372.2	1355.9	187.9	966.0	0.1	965.9	0.8	-
13/06/12	174.7	170	-	-	1171.5	1177.4	186.0	937.2	0.0	937.2	0.9	-
14/06/12	175.7	163	1014	624	1520.8	1486.9	197.7	953.2	0.1	953.1	0.7	-
15/06/12	176.7	223	-	-	1474.5	1381.6	207.8	988.5	0.2	988.4	0.6	-
19/06/12	181.0	180	-	-	1327.7	1305.9	199.4	937.1	0.1	936.9	0.6	-
20/06/12	181.7	138	1244	644	1473.7	1366.3	200.1	910.4	0.1	910.3	3.0	-
21/06/12	182.7	330	-	-	1455.1	1385.3	191.2	947.2	0.1	947.1	0.6	-
21/06/12	182.9	205	-	-	1398.1	1329.5	191.5	1037.9	0.0	1037.8	0.9	-
22/06/12	183.7	213	1096	614	1487.2	1442.9	191.3	957.7	0.0	957.6	0.2	-
22/06/12	183.8	185	-	-	1328.1	1383.3	187.6	894.1	0.0	894.0	0.1	-
25/06/12	187.0	155	-	-	1484.4	1403.0	188.0	942.2	0.0	942.2	0.3	-
26/06/12	187.7	108	-	-	1484.0	1389.6	195.2	970.7	0.0	970.6	0.7	-
27/06/12	188.7	445	1068	550	-	-	165.7	943.8	-0.1	943.9	0	42.5
27/06/12	189.0	218	-	-	1280.3	1275.1	170.9	925.6	0.1	925.5	0	32.5
28/06/12	189.8	173	-	-	1304.4	1274.1	164.5	927.2	0.1	927.1	0	32.9
28/06/12	190.0	270	-	-	1405.6	1383.4	167.4	978.0	0.1	977.9	5.0	43.4
29/06/12	190.7	125	1046	578	1501.7	1475.9	165.4	958.1	0.1	958.0	0	32.0
02/07/12	193.7	85	1104	662	1374.7	1293.3	164.5	927.2	0.1	927.1	0	32.5
17/07/12	208.6	100	988	768	1055.5	977.4	169.9	763.4	5.1	758.3	0	42.5
18/07/12	209.9	95	-	-	1406.4	1381.0	201.2	983.0	0.1	982.9	1.0	163.9

F 3.1.2 Effluent wastewater - Study 3 - Phase 1 (cont'd)

Date	Day No.	SS	COD	COD _f	TN	TN _f	NH ₄ -N	TON	NO ₂ -N	NO ₃ -N	PO ₄ -P	Alk
		mg/l	mg/l	mg/l	mg/l	mg/l	mg/l	mg/l	mg/l	mg/l	mg/l	mg/l
20/07/12	211.8	128	--	-	1408.3	1393.1	205.4	988.0	0.3	987.7	0.6	256.7
24/07/12	215.8	50	942	787	1378.8	1392.2	232.8	957.6	0.0	957.6	2.2	239.6
25/07/12	216.8	50	-	-	1406.0	1367.8	259.9	820.5	0.1	820.4	1.4	237.5
26/07/12	217.7	85	1138	762	1266.1	1160.5	304.8	920.5	0.1	920.4	1.6	243.9
30/07/12	222.0	85	-	-	1014.0	950.8	612.6	859.1	84.4	774.7	2.8	235.7
31/07/12	222.7	93	-	-	1004.1	946.7	660.2	911.5	84.4	827.1	2.8	256.8
01/08/12	223.7	128	1092	980	1192.0	1144.4	797.9	913.4	93.7	819.7	3.2	253.5
02/08/12	224.7	83	-	-	1004.9	986.1	547.7	931.9	224.1	707.8	2.1	247.6
08/08/12	230.7	83	-	-	1171.1	1133.8	642.4	922.3	182.2	740.0	2.0	251.2
09/08/12	231.7	113	-	-	1182.0	1156.1	485.7	929.8	241.2	688.6	1.9	198.7
10/08/12	232.7	75	1102	960	1228.1	1194.7	453.6	864.0	272.2	591.8	1.7	229.8
14/08/12	236.7	28	-	-	1285.1	1211.6	245.8	896.7	291.0	605.7	1.2	395.4
14/08/12	236.7	20	-	-	1208.7	1178.6	239.6	934.1	403.2	530.9	0.5	348.3
15/08/12	237.7	33	-	-	1283.3	1133.3	217.7	933.8	408.1	525.7	0.5	317.9
15/08/12	238.0	83	-	-	1275.1	1224.8	215.9	965.3	344.7	620.6	1.3	314.9
16/08/12	238.7	88	1258	1050			184.7	1021.4	382.5	638.9	1.3	256.4
17/08/12	239.7	53	879	797	1274.9	1251.3	142.6	1042.3	486.4	555.9	0.6	343.5
21/08/12	243.7	118	-	-	1256.6	1186.6	132.4	1068.8	495.3	573.5	0.6	335.7
22/08/12	244.8	98	-	-	1275.8	1299.8	93.9	1166.7	339.4	827.3	0.3	329.0
22/08/12	245.0	70	908	855	1372.2	1370.6	84.7	1083.0	300.2	782.8	0.8	346.2
24/08/12	246.7	155	-	-	1427.1	1370.0	76.8	1061.1	305.8	755.3	2.0	226.9
28/08/12	250.7	108	-	-	1537.0	1494.3	70.5	1049.9	356.1	693.8	0.9	207.5
29/08/12	251.7	98	965	900	1542.8	1474.3	79.3	1037.9	347.4	690.5	0.8	215.7
30/08/12	252.7	128	-	-	1444.7	1336.3	80.2	1072.3	325.3	747.0	2.1	212.7

F 3.1.3.1 Study 3 - Phase 1 – LLIS 1

	min.	COD mg/l	COD _f mg/l	TN mg/l	TN _f mg/l	NH ₄ -N mg/l	TON mg/l	NO ₂ -N mg/l	NO ₃ -N mg/l	PO ₄ -P mg/l	Alk mg/l	
450 min. aerobic period	Inf.	0	1420	1280	1021.4	964.4	1100.2	3.6	1.3	2.4	6.5	5564.0
	1				910.1	908.0	199.4	597.1	4.7	592.5	0.1	328.5
	5	702	644	914.1	885.6	162.8	606.9	4.8	602.1	0.1	100.9	
	10			905.3	880.2	152.2	605.1	4.9	600.2	0.3	77.5	
	15			904.3	878.9	129.9	614.3	5.0	609.3	0.1	60.7	
	20			903.6	876.2	128.8	602.4	5.0	597.4	0.5	56.9	
	25	682	590	899.5	872.7	130.1	584.2	5.0	579.2	0.2	57.4	
	30			897.0	868.0	124.1	624.6	4.9	619.7	0.1	52.7	
	35			894.7	864.5	128.2	628.6	5.0	623.5	0.1	46.8	
	40			890.4	861.8	126.1	619.6	5.1	614.5	0.0	48.8	
	45	670	570	889.4	858.0	127.5	630.3	5.1	625.2	0.1	45.2	
	60			889.0	857.3	126.3	619.7	5.0	614.6	0.4	53.0	
	75			887.4	854.8	129.7	632.0	5.3	626.7	0.1	46.2	
	90			887.5	852.2	125.6	629.8	5.4	624.5	0.1	45.7	
	105	666	548	886.8	852.0	123.4	631.2	5.4	625.9	0.1	44.3	
	120			887.5	853.5	123.3	629.0	5.4	623.7	0.0	46.7	
	135			885.8	855.2	128.2	627.5	5.4	622.2	0.1	44.9	
	150			883.9	852.2	125.3	624.1	5.4	618.7	0.5	53.9	
	165	648	568	882.8	849.1	124.7	617.4	5.5	611.9	0.2	49.0	
	180			874.2	851.1	120.9	634.6	5.6	629.0	0.0	46.1	
	195			875.4	847.5	111.8	610.4	5.5	604.9	1.2	58.6	
	210			875.4	846.4	125.4	638.1	5.9	632.2	0.7	44.8	
	225	640	570	876.8	842.5	112.7	615.6	5.6	610.0	2.0	54.7	
	240			879.0	841.7	109.2	603.6	5.6	597.9	0.7	104.6	
	255			878.3	864.0	115.7	632.2	5.7	626.4	0.9	80.8	
	270			875.8	831.9	124.4	653.0	5.6	647.4	0.7	51.7	
	285	640	566	876.9	866.0	124.2	645.9	5.6	640.3	1.4	41.6	
	300			875.0	868.3	112.6	620.8	5.6	615.2	0.7	43.8	
	315			876.1	870.4	126.5	624.0	5.6	618.4	1.6	47.7	
	330			873.8	865.2	123.6	627.4	5.8	621.6	0.6	48.9	
	345	638	568	876.7	863.3	133.7	626.9	5.8	621.0	0.4	48.6	
	360			871.8	854.4	120.0	643.5	5.6	637.9	1.1	62.2	
	375			866.3	858.8	131.9	643.7	5.6	638.1	2.1	43.2	
	390			866.9	857.4	134.7	656.5	5.6	650.8	2.6	48.7	
	405			867.6	856.6	136.3	637.1	5.6	631.5	2.0	49.6	
	420			865.6	858.3	138.2	657.4	5.7	651.7	1.8	42.9	
	435	650	598	871.6	853.4	136.0	658.8	5.7	653.1	1.8	33.0	
	450			871.5	848.8	133.9	657.4	5.7	651.7	1.4	39.0	
	S	465			872.4	845.1	136.2	658.1	5.7	652.4	1.1	39.0
		480	642	552	872.4	847.8	136.0	647.4	5.7	641.7	1.5	46.4
	Eff.	495	646	582	871.1	849.5	118.6	641.1	5.6	635.5	0.5	40.6

S – 45 minute settlement period

F 3.1.3.2 Study 3 - Phase 1 – LLIS 1

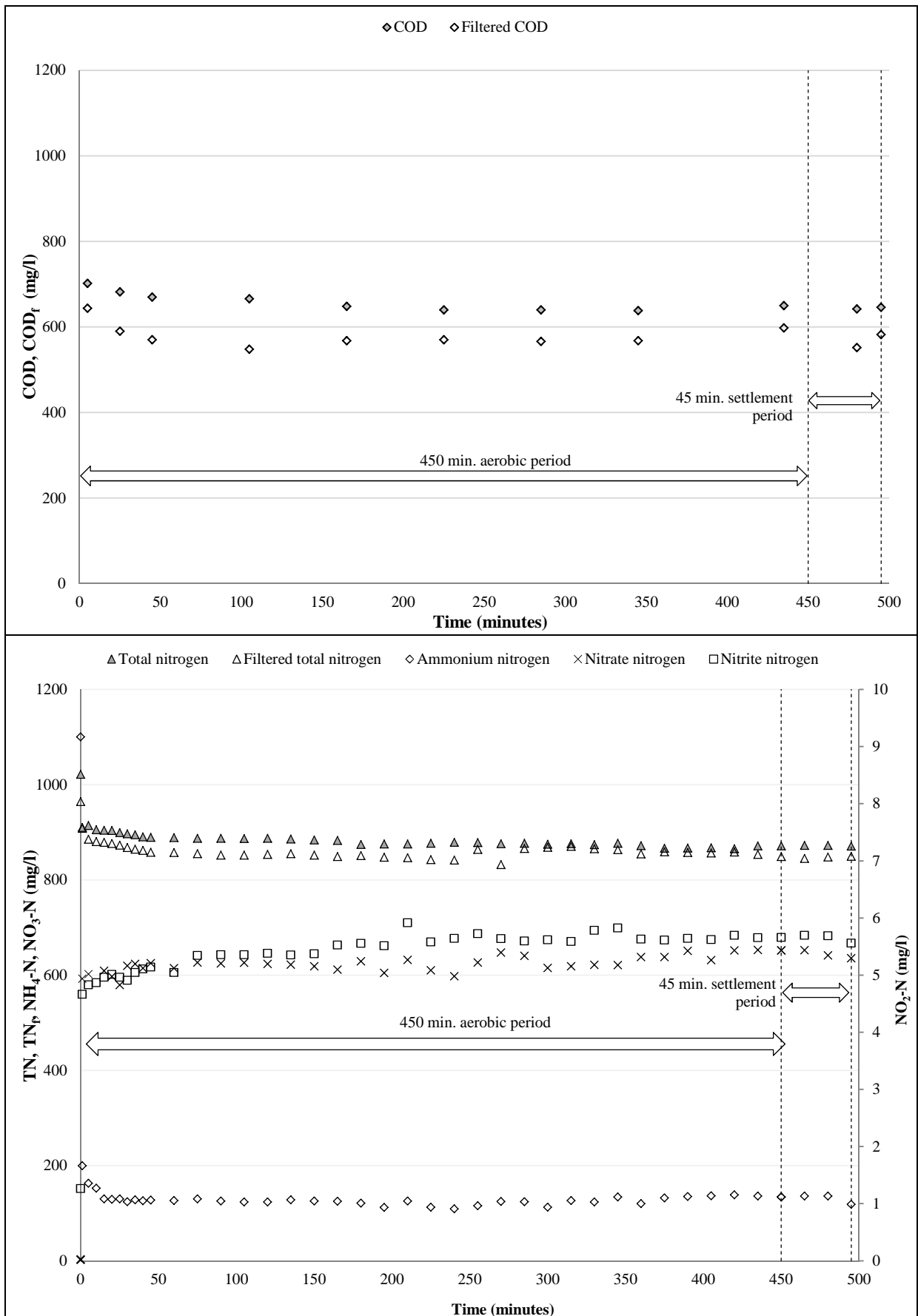

F 3.1.1.2 Study 3 - Phase 1 – LLIS 1 (cont'd)

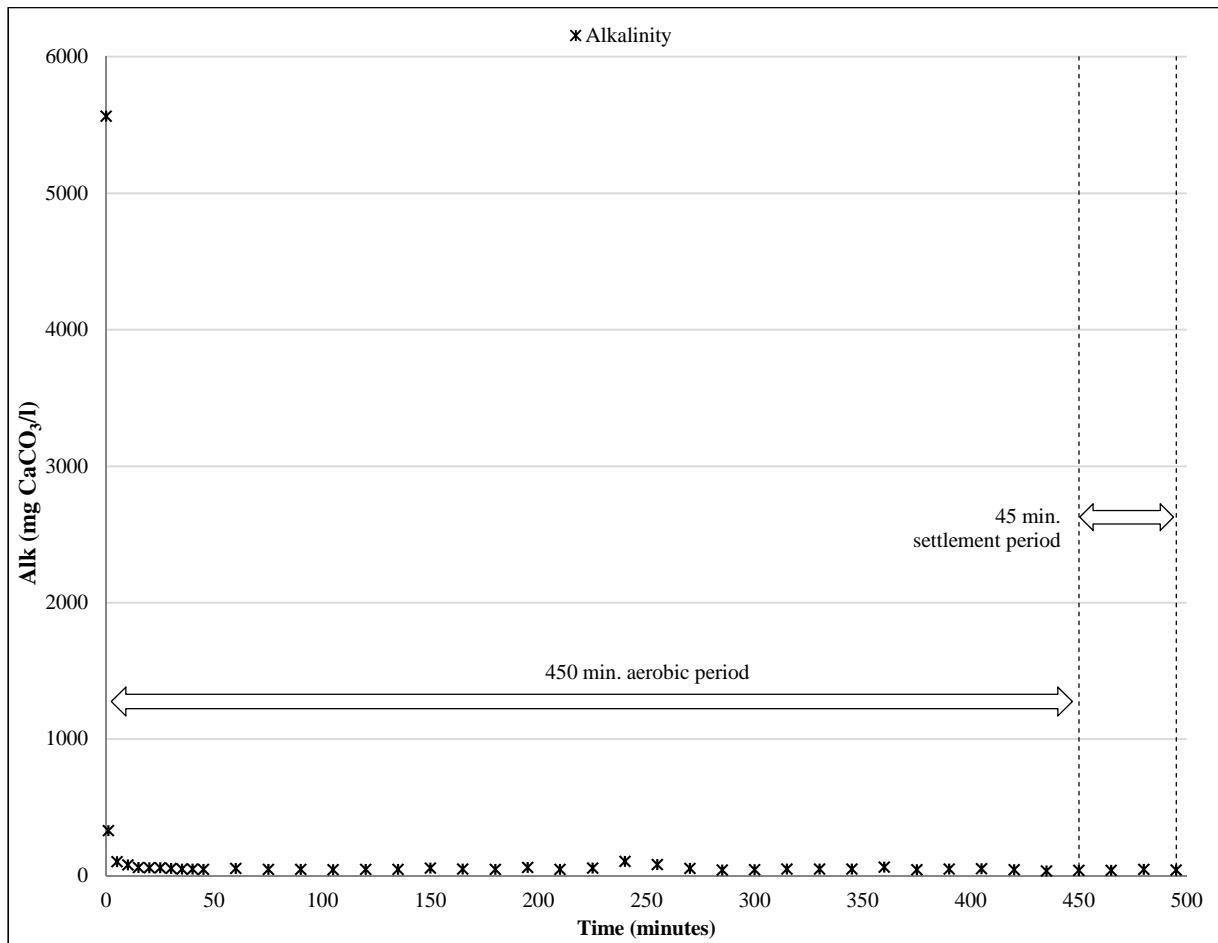

F 3.1.4.1 Study 3 - Phase 1 – LLIS 2

	min.	COD mg/l	COD _f mg/l	TN mg/l	TN _f mg/l	NH ₄ -N mg/l	TON mg/l	NO ₂ -N mg/l	NO ₃ -N mg/l	PO ₄ -P mg/l	Alk mg/l	
450 min. aerobic period	Inf.	0	1798	1602	1190.2	1070.2	1210.2	7.9	7.5	0.4	18.9	6257.0
	1	1064	958	1139.4	1024.5	713.7	394.3	4.0	390.4	14.8	314.9	
	5			1088.6	978.9	217.1	780.8	0.4	780.4	10.7	103.4	
	10	982	912	1080.2	986.1	211.6	755.9	0.5	755.4	10.7	87.2	
	15			1071.9	993.3	206.1	730.9	0.5	730.4	10.8	58.2	
	20	976	898	1077.8	990.2	201.7	720.5	0.5	720.0	10.8	58.3	
	25			1083.8	987.1	197.3	710.1	0.4	709.7	10.7	64.6	
	30	924	892	1080.1	989.6	198.7	714.2	0.4	713.7	10.7	50.5	
	35			1076.4	992.1	200.1	718.2	0.4	717.8	10.7	47.9	
	40	908	876	1077.5	994.2	202.0	728.3	0.5	727.8	10.8	54.9	
	45			1078.5	996.3	203.8	738.4	0.5	737.9	10.9	43.3	
	60	912	878	1072.4	994.3	206.1	749.2	0.5	748.7	10.8	54.3	
	75			1066.3	992.3	208.3	760.0	0.5	759.5	10.7	51.9	
	90	908	882	1063.5	990.8	205.4	735.4	0.4	734.9	10.7	43.8	
	105			1060.7	989.3	202.5	710.8	0.4	710.4	10.7	45.3	
	120	898	870	1061.3	989.4	201.9	721.4	0.3	721.1	10.8	52.5	
	135			1061.9	989.4	201.4	732.1	0.2	731.9	10.8	43.1	
	150	900	892	1060.7	991.3	201.3	721.3	0.4	721.0	10.8	55.2	
	165			1059.4	993.1	201.3	710.5	0.5	710.0	10.7	55.1	
	180	898	880	1060.7	992.2	201.0	722.8	0.5	722.3	10.7	44.2	
	195			1061.9	991.2	200.8	735.2	0.5	734.7	10.7	60.0	
	210	892	872	1049.8	989.8	202.1	722.7	0.6	722.2	10.7	50.4	
	225			1037.7	988.4	203.5	710.3	0.6	709.7	10.8	52.5	
	240	896	870	1040.0	985.9	197.7	711.0	0.6	710.4	10.8	107.1	
	255			1042.3	983.5	192.0	711.8	0.6	711.2	10.8	90.9	
	270	898	868	1038.4	980.2	193.9	711.5	0.6	711.0	10.8	49.5	
	285			1034.5	977.0	195.8	711.3	0.6	710.7	10.8	42.6	
	300	896	862	1037.0	973.6	196.0	702.1	0.5	701.6	10.8	49.3	
	315			1039.6	970.2	196.2	692.9	0.5	692.4	10.7	45.7	
	330			1038.2	966.7	199.1	716.5	0.5	716.1	10.4	50.1	
	345	892	854	1036.7	963.2	202.1	740.2	0.5	739.7	10.0	54.7	
	360			1035.4	963.4	202.4	716.6	0.5	716.1	10.0	59.6	
	375			1034.0	963.7	202.7	692.9	0.5	692.4	10.0	44.3	
	390	894	852	1032.5	960.2	199.4	693.5	0.5	693.0	10.0	54.7	
	405			1031.0	956.8	196.0	694.1	0.5	693.7	10.1	47.5	
	420	892	846	1029.5	953.7	197.7	715.7	0.5	715.2	10.0	43.9	
	435			1028.1	950.6	197.2	708.5	0.5	708.1	10.1	37.1	
	S	450	856	844	1028.4	945.8	195.7	703.7	0.5	703.2	10.0	37.3
		465			1028.8	941.0	196.7	707.2	0.3	706.9	10.1	40.0
		480	878	840	1029.7	933.7	189.7	718.1	0.1	718.0	10.1	52.1
		Eff.	495	852	842	1030.5	926.3	190.1	712.3	0.2	710.3	10.1

S – 45 minute settlement period

F 3.1.4.2 Study 3 - Phase 1 – LLIS 2

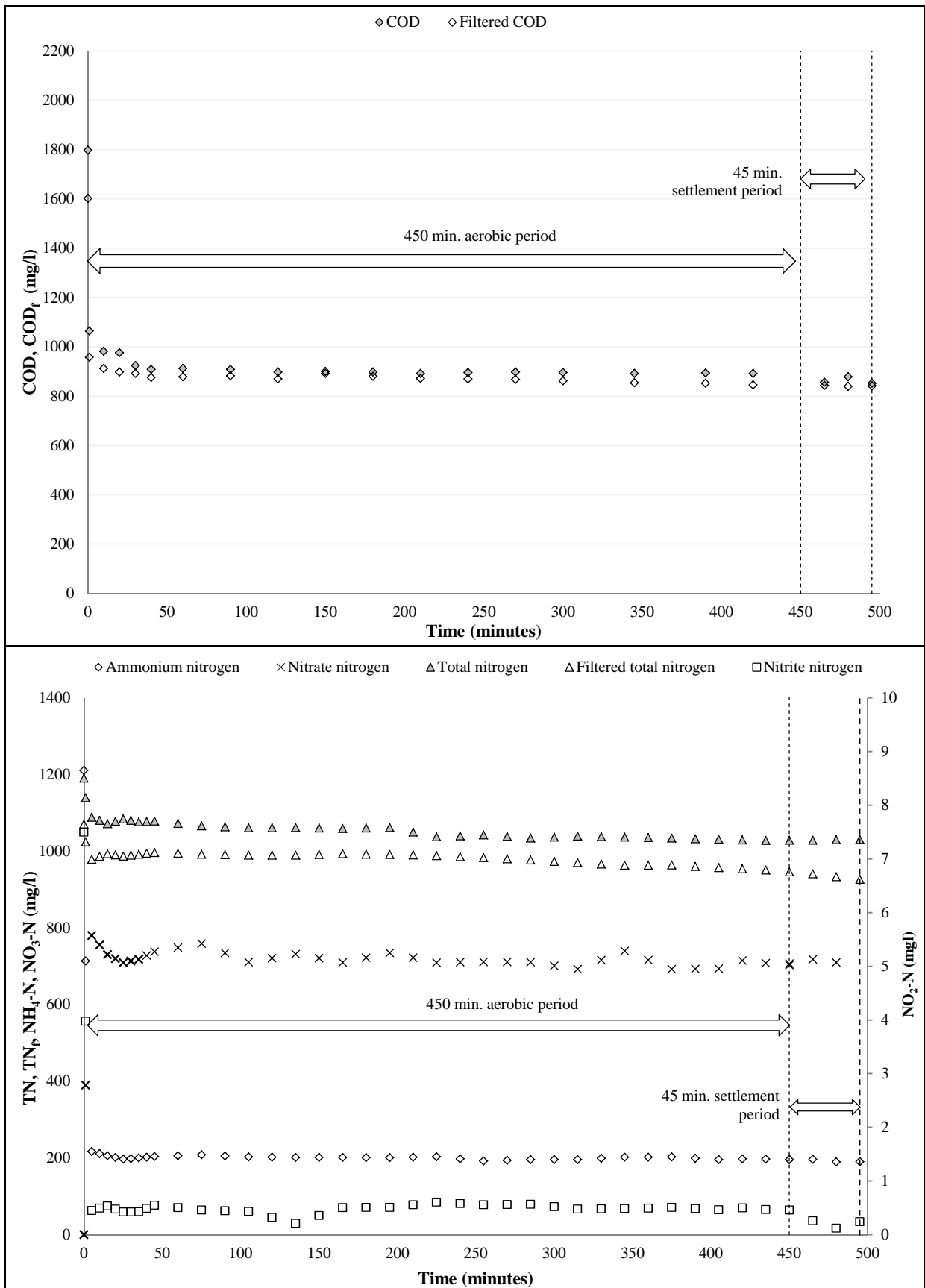

F 3.1.4.2 Study 3 - Phase 1 – LLIS 2 (cont'd)

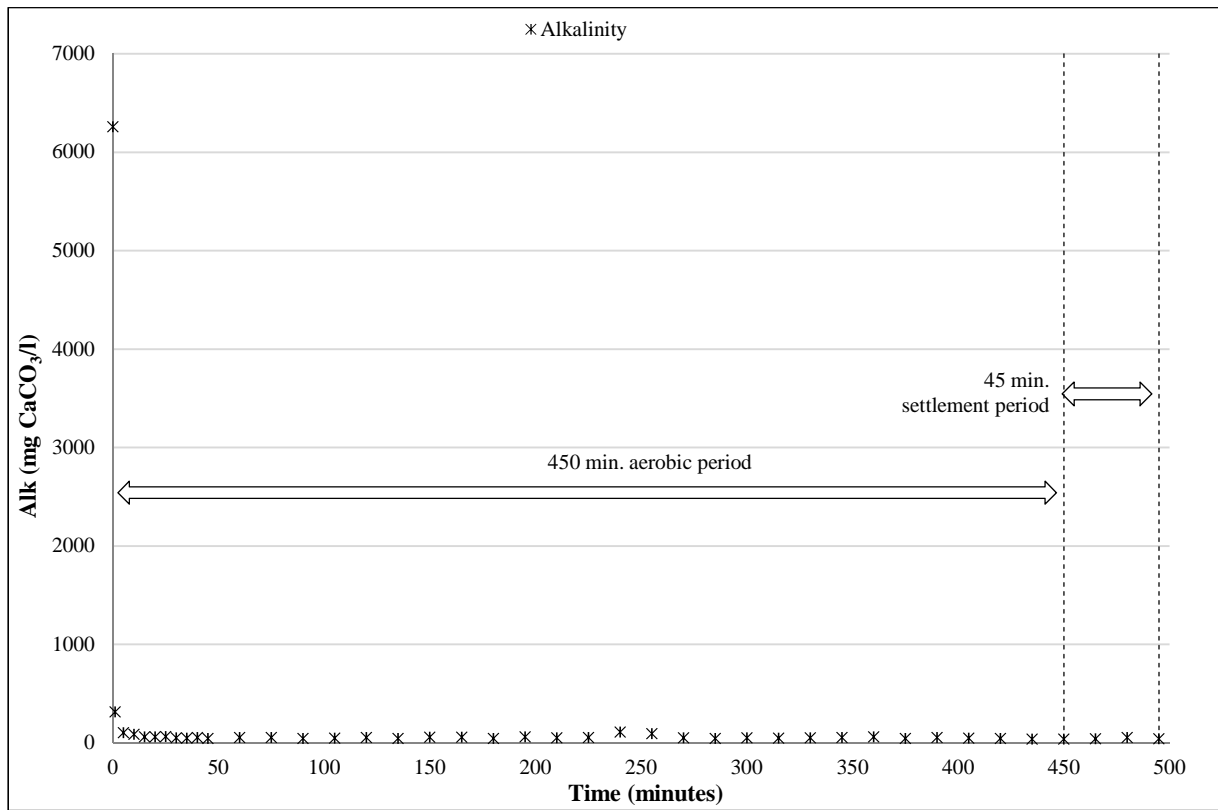

F 3.1.4.1 Study 3 - Phase 1 – LLIS 3

	min.	COD mg/l	COD _f mg/l	TN mg/l	TN _f mg/l	NH ₄ -N mg/l	TON mg/l	NO ₂ -N mg/l	NO ₃ -N mg/l	PO ₄ -P mg/l	Alk mg/l	
450 min. aerobic period	Inf.	0		1636.0	1606.1	1045.3	2.5	0.4	2.1	3.4	6542	
		1		1541.2	1515.1	632.7	645.9	0.3	645.6	2.3	3323	
		5		1446.4	1424.1	220.1	1289.3	0.1	1289.1	1.1	104	
		10		1441.6	1425.9	224.4	1256.1	0.1	1256.0	1.1	76	
		15		1436.9	1427.6	228.8	1223.0	0.1	1222.9	1.1	48	
		20		1438.5	1435.2	225.7	1220.9	0.1	1220.9	1.1	41	
		25		1440.1	1442.7	222.6	1218.9	0.1	1218.8	1.1	34	
		30		1438.3	1436.2	222.0	1215.4	0.1	1215.3	1.0	37	
		35		1436.5	1429.7	221.4	1211.9	0.1	1211.8	0.8	40	
		40		1436.1	1426.1	222.6	1224.4	0.1	1224.3	1.0	39	
		45		1435.6	1422.6	223.7	1236.9	0.1	1236.8	1.1	38	
		60		1433.1	1430.4	222.4	1227.8	0.1	1227.7	0.6	37	
		75		1430.5	1438.3	221.1	1218.6	0.0	1218.6	0.1	36	
		90		1427.3	1436.5	220.7	1228.9	0.1	1228.8	0.6	36	
		105		1424.1	1434.8	220.4	1239.1	0.1	1239.0	1.1	36	
		120		1428.2	1431.3	220.9	1232.1	0.1	1232.1	1.1	37	
		135		1432.3	1427.7	221.5	1225.2	0.0	1225.1	1.1	38	
		150		1431.4	1424.5	220.8	1206.7	0.0	1206.6	1.0	35	
		165		1430.4	1421.3	220.1	1188.2	0.0	1188.2	1.0	32	
		180		1430.9	1413.9	220.1	1192.2	0.0	1192.2	1.0	33	
		195		1431.4	1406.5	220.2	1196.2	0.0	1196.2	1.0	33	
		210		1429.5	1406.7	219.7	1188.8	0.0	1188.7	1.0	34	
		225		1427.5	1406.8	219.2	1181.3	0.1	1181.3	1.0	35	
		240		1427.2	1403.8	218.6	1194.6	0.1	1194.5	1.0	35	
		255		1427.0	1400.9	217.9	1207.9	0.1	1207.8	1.0	35	
		270		1418.0	1402.2	218.2	1205.4	0.1	1205.3	1.0	35	
		285		1409.0	1403.4	218.4	1202.9	0.0	1202.8	1.0	34	
		300		1406.6	1403.5	218.0	1207.9	0.0	1207.9	0.9	33	
		315		1404.3	1403.5	217.5	1213.0	0.0	1213.0	0.8	32	
		330		1399.9	1403.1	216.5	1207.6	0.0	1207.6	0.6	35	
		345		1395.6	1402.6	215.5	1202.2	0.0	1202.2	0.4	37	
		360		1394.2	1404.2	214.7	1203.1	0.0	1203.1	0.5	34	
		375		1392.8	1405.8	213.9	1204.1	0.0	1204.0	0.5	30	
		390		1390.0	1400.5	213.5	1204.9	0.0	1204.8	0.5	32	
		405		1387.1	1395.1	213.1	1205.7	0.1	1205.6	0.5	34	
		420		1381.8	1376.1	211.1	1206.9	0.0	1206.8	0.4	34	
		435		1376.4	1357.0	209.1	1208.1	0.0	1208.0	0.2	33	
		450		1374.9	1362.4	208.9	1209.6	0.0	1209.6	0.8	35	
	S		465		1373.4	1367.8	208.6	1211.2	0.1	1211.2	1.4	37
			480		1372.9	1364.0	208.4	1216.7	0.1	1216.6	0.2	30
	Eff.		495		1372.3	1360.3	207.3	1215.8	0.1	1215.7	1.7	33

S- 45 min settlement period

F 3.1.4.2 Study 3 - Phase 1 – LLIS 3

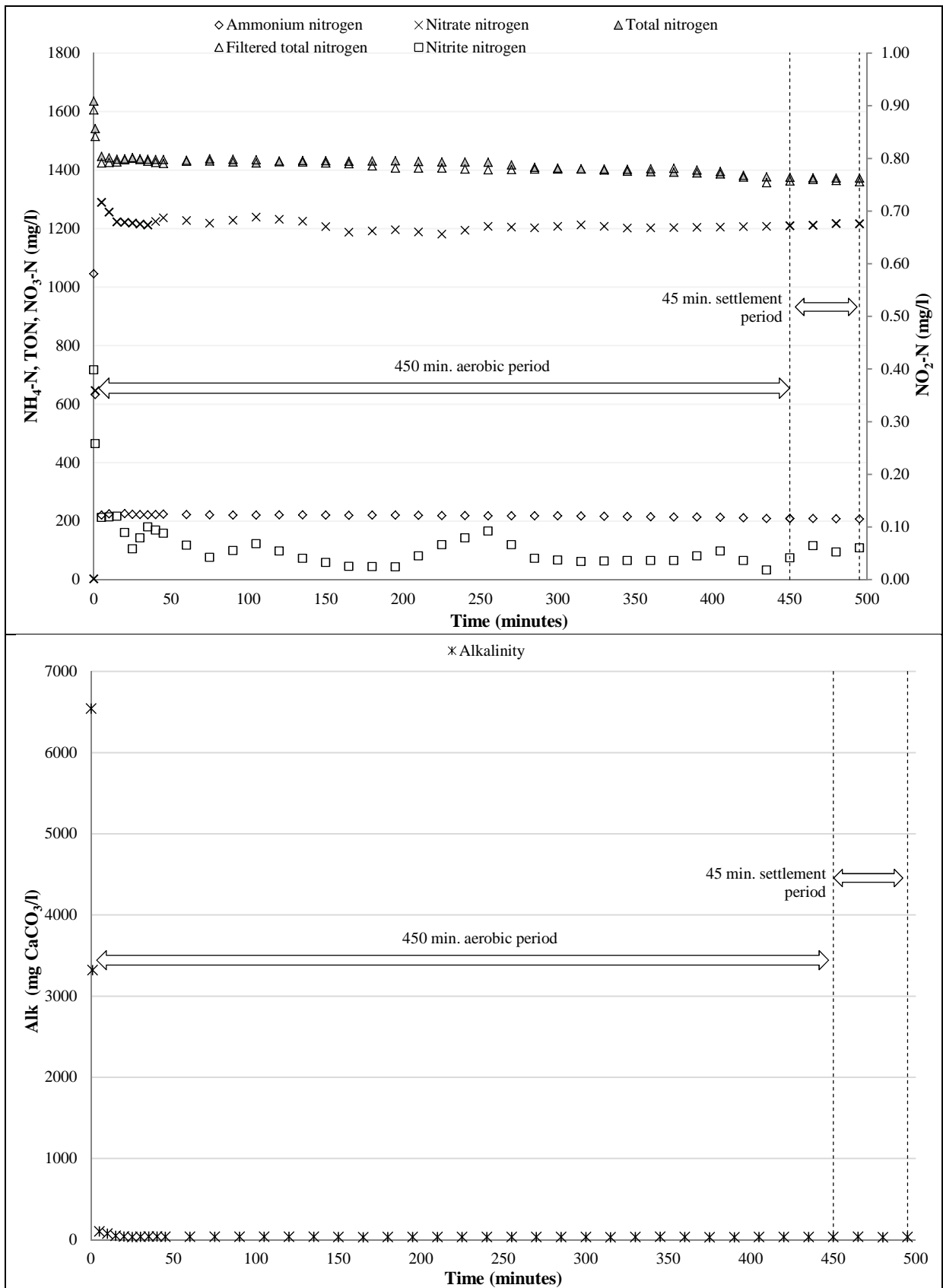

F 3.2.5.1 Study 3 - Phase 1 – LLIS 4

	min.	COD mg/l	COD _f mg/l	TN mg/l	TN _f mg/l	NH ₄ -N mg/l	TON mg/l	NO ₂ -N mg/l	NO ₃ -N mg/l	PO ₄ -P mg/l	Alk mg/l	
450 min. aerobic period	Inf.	0	1494	1210	1969.9	1798.7	927.1	17.9	0.1	17.7	9.4	6388
	1				1874.3	1720.4	567.0	618.3	0.2	618.1	5.2	3244
	5	718	586		1778.7	1682.1	206.9	1218.8	0.2	1218.5	1.0	99
	10				1765.8	1670.2	202.1	1233.2	0.3	1233.0	1.0	72
	15				1752.8	1698.3	197.2	1247.7	0.4	1247.4	1.0	44
	20				1737.7	1685.6	195.3	1244.3	0.4	1243.9	1.1	38
	25	716	580		1742.6	1672.9	193.4	1240.8	0.4	1240.4	1.1	33
	30				1735.0	1696.0	193.2	1237.1	0.4	1236.7	1.1	35
	35				1727.3	1691.0	193.1	1233.5	0.4	1233.1	1.1	37
	40				1723.2	1687.7	193.2	1245.8	0.4	1245.4	1.1	37
	45				1729.0	1683.3	193.2	1258.1	0.4	1257.7	1.1	38
	60	718	484		1720.7	1684.6	192.3	1271.7	0.4	1271.3	1.1	37
	75				1750.8	1681.9	193.7	1240.4	0.4	1240.0	1.1	39
	90				1690.8	1662.3	195.1	1209.0	0.4	1208.6	1.1	36
	105	712	582		1689.1	1653.4	195.9	1220.1	0.4	1219.7	1.1	36
	120				1687.4	1644.6	196.6	1231.1	0.4	1230.7	1.1	36
	135				1693.0	1652.8	192.2	1226.3	0.4	1225.9	1.0	36
	150				1698.6	1661.1	187.9	1221.5	0.4	1221.1	0.9	36
	165	682	578		1700.8	1637.5	186.3	1236.7	0.4	1236.3	1.0	33
	180				1703.1	1613.9	184.8	1251.9	0.4	1251.5	1.1	30
	195				1710.4	1656.8	186.4	1269.7	0.4	1269.2	1.1	31
	210				1707.7	1659.6	188.1	1287.4	0.5	1286.9	1.1	33
	225	678	576		1712.8	1658.4	189.8	1272.0	0.5	1271.6	1.1	33
	240				1717.9	1657.1	191.4	1256.7	0.5	1256.2	1.1	34
	255				1713.9	1647.2	179.6	1257.0	0.5	1256.5	1.0	34
	270				1679.9	1597.3	167.7	1257.2	0.5	1256.7	1.0	35
	285	678	564		1692.9	1603.0	177.5	1257.5	0.5	1257.0	1.0	34
	300				1698.9	1608.8	187.3	1257.7	0.5	1257.2	1.0	32
	315				1692.1	1615.1	187.9	1271.8	0.5	1271.3	0.9	32
	330				1688.3	1621.4	188.5	1286.0	0.5	1285.5	0.9	31
	345	676	566		1687.1	1646.2	189.3	1283.9	0.5	1283.4	0.9	34
	360				1684.0	1641.0	190.0	1281.8	0.5	1281.3	0.9	37
	375				1679.7	1637.9	194.0	1276.7	0.5	1276.2	0.9	33
	390				1682.4	1604.9	197.9	1271.6	0.5	1271.1	0.8	29
	405				1688.9	1607.3	196.6	1272.2	0.5	1271.7	0.7	32
	420				1685.4	1609.8	195.3	1272.7	0.5	1272.2	0.6	34
	435	680	560		1678.7	1606.7	195.1	1269.5	0.5	1269.0	0.6	33
	450				1651.0	1612.6	195.0	1266.4	0.5	1265.9	0.6	32
	S	465			1648.7	1594.3	191.1	1262.6	0.5	1262.1	0.5	36
		480	680	554	1640.8	1591.2	189.1	1261.3	0.5	1260.8	0.7	29
	Eff.	495	672	556	1638.9	1588.1	192.8	1259.4	0.5	1258.8	0.7	33

S- 45 min settlement period

F 3.1.5.2 Study 3 - Phase 1 – LLIS 4

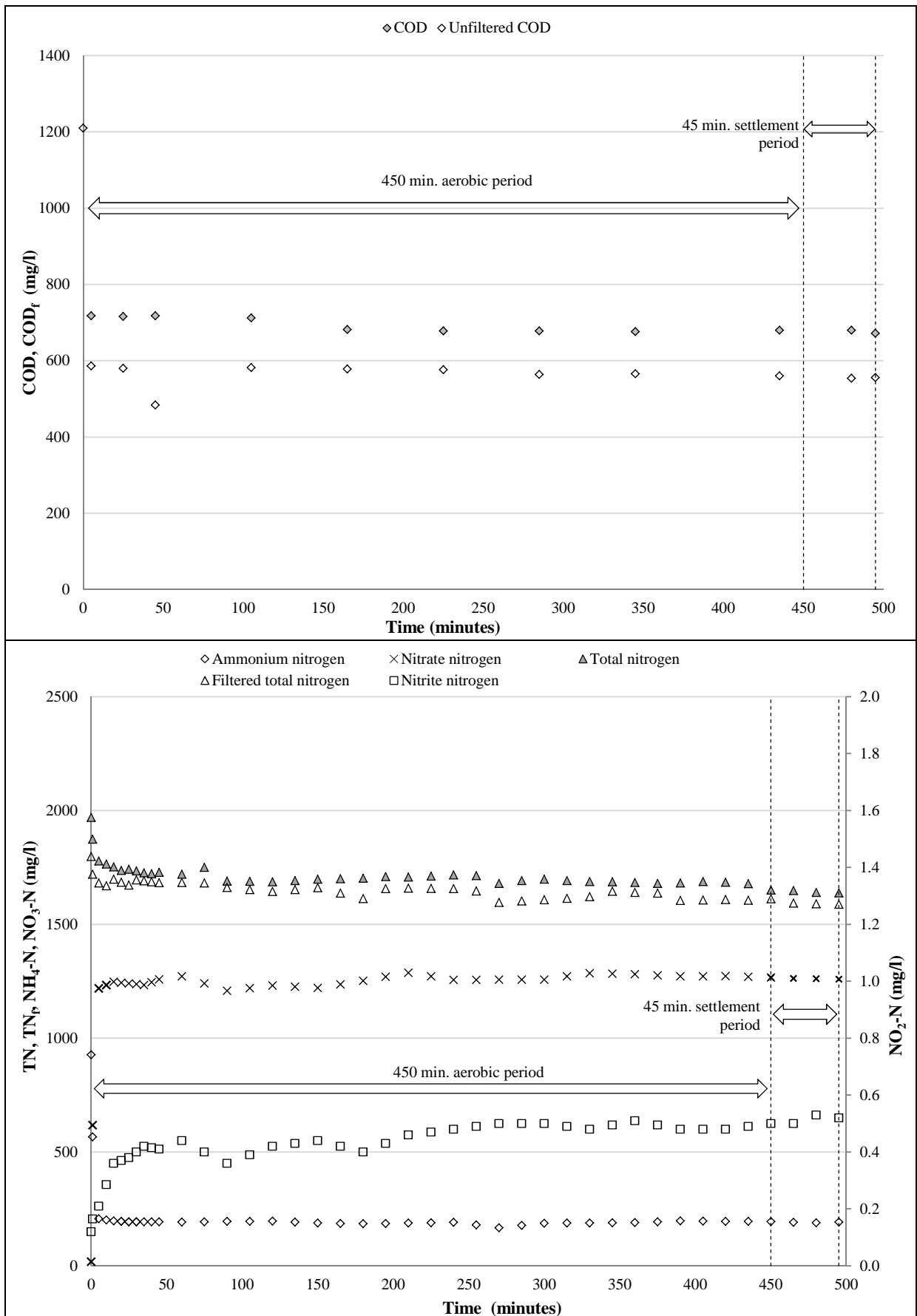

F 3.1.5.2 Study 3 - Phase 1 – LLIS 4

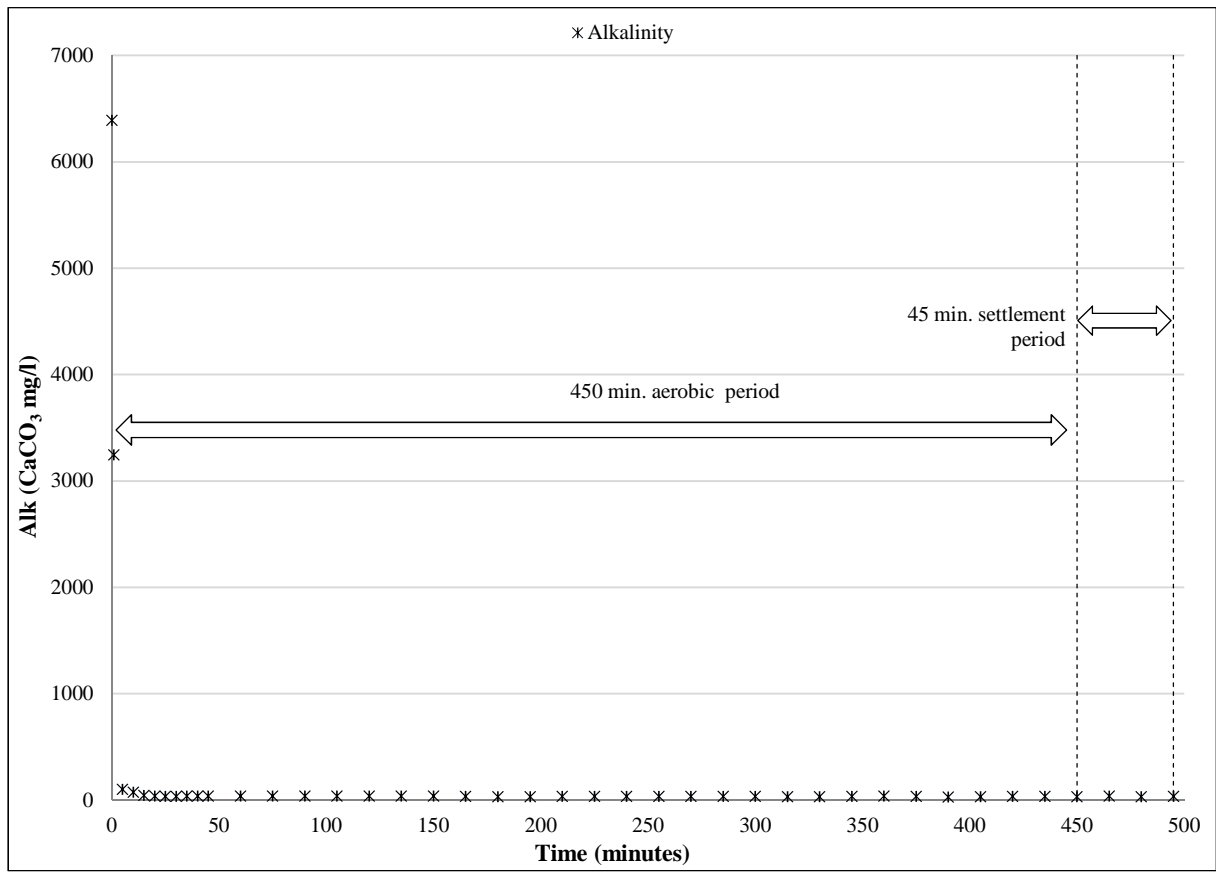

F 3.1.6.1 Study 3 - Phase 1 – LLIS 5

	min.	COD mg/l	COD _f mg/l	TN mg/l	TN _f mg/l	NH ₄ -N mg/l	TON mg/l	NO ₂ -N mg/l	NO ₃ -N mg/l	PO ₄ -P mg/l	Alk mg/l	
450 min. aerobic period	Inf.	0	1544	1208	1619.7	1459.7	2216.1	363.1	1.4	361.7	6.5	6928
	1				1571.3	1414.6	788.9	1107.2	2.9	1104.3	0.1	3902
	5	798	630		1509.5	1373.2	307.6	1092.1	4.1	1088.0	0.1	875
	10				1501.7	1366.7	289.1	1077.4	4.1	1073.3	0.3	620
	15				1500.7	1365.9	288.8	1062.6	4.1	1058.5	0.1	364
	20				1499.7	1365.0	290.4	1059.1	4.1	1055.0	0.5	351
	25	740	578		1500.1	1363.6	289.2	1055.5	4.1	1051.4	0.2	337
	30				1500.6	1362.1	290.2	1022.9	4.1	1018.8	0.1	340
	35				1496.2	1358.7	287.5	990.3	4.0	986.3	0.1	344
	40				1491.8	1355.2	285.1	989.7	4.1	985.6	0.0	286
	45	738	544		1488.9	1352.7	288.0	989.1	4.2	984.9	0.1	227
	60				1486.0	1350.1	288.5	1018.2	4.3	1013.9	0.4	256
	75				1480.8	1344.1	296.3	1047.2	4.3	1042.9	0.1	284
	90				1475.6	1338.1	298.4	1048.6	4.2	1044.4	0.1	295
	105	740	546		1476.8	1334.5	295.0	1050.0	4.2	1045.8	0.1	305
	120				1477.9	1330.9	284.8	1008.3	4.2	1004.1	0.0	271
	135				1475.6	1327.3	284.3	966.6	4.3	962.3	0.1	238
	150				1473.3	1323.6	283.7	983.1	4.3	978.8	0.5	202
	165	736	544		1471.1	1324.8	284.1	999.6	4.2	995.4	0.2	166
	180				1468.8	1326.0	280.9	997.3	4.3	993.0	0.0	196
	195				1467.8	1325.9	284.9	994.9	4.3	990.6	1.2	227
	210				1466.9	1325.9	284.1	997.1	4.3	992.7	0.7	222
	225	742	560		1465.2	1324.4	284.8	999.2	4.4	994.8	2.0	218
	240				1463.6	1323.0	279.3	1008.3	4.3	1003.9	0.7	231
	255				1458.6	1321.7	298.5	1017.3	4.3	1013.0	0.9	245
	270				1453.7	1320.3	324.5	1018.8	4.4	1014.4	0.6	256
	285	738	554		1451.2	1322.2	314.0	1020.2	4.4	1015.8	1.4	267
	300				1448.7	1324.2	283.1	988.4	4.2	984.2	0.7	227
	315				1449.9	1323.2	286.2	956.6	4.3	952.3	1.6	187
	330				1451.1	1322.2	283.2	965.9	4.3	961.6	0.6	197
	345	736	564		1446.5	1321.8	283.4	975.2	4.2	971.0	0.3	207
	360				1441.9	1321.4	283.8	970.1	4.3	965.8	1.1	192
375				1443.3	1322.5	283.6	964.9	4.4	960.5	2.1	178	
390				1444.6	1323.5	282.9	981.6	4.4	977.2	2.6	165	
405				1444.1	1323.2	281.2	998.2	4.4	993.8	2.0	152	
420				1443.6	1322.9	282.9	970.9	4.2	966.7	1.8	197	
435	720	576		1446.2	1323.4	279.7	943.6	4.2	939.4	1.8	243	
450				1448.8	1324.0	279.7	946.8	4.2	942.5	1.4	204	
S	465			1446.6	1322.5	280.6	949.9	4.3	945.6	1.1	164	
	480	722	504	1444.4	1321.1	281.3	951.2	4.4	946.8	1.5	125	
Eff.	495	724	572	1445.1	1317.8	282.5	952.5	4.3	948.2	0.5	86	

S- 45 min settlement period

F 3.1.6.2 Study 3 - Phase 1 – LLIS 5

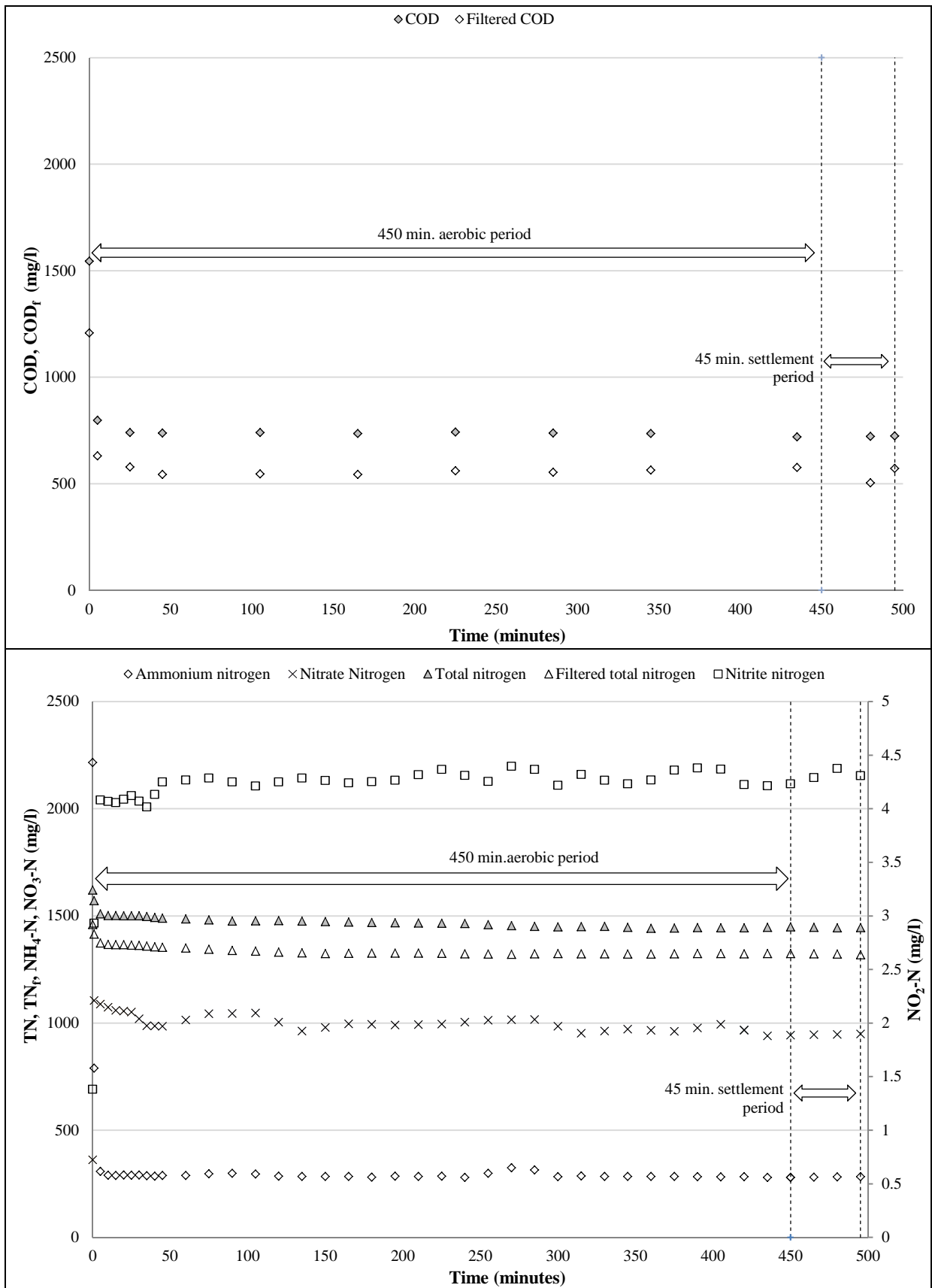

F 3.1.6.2 Study 3 - Phase 1 – LLIS 5 (cont'd)

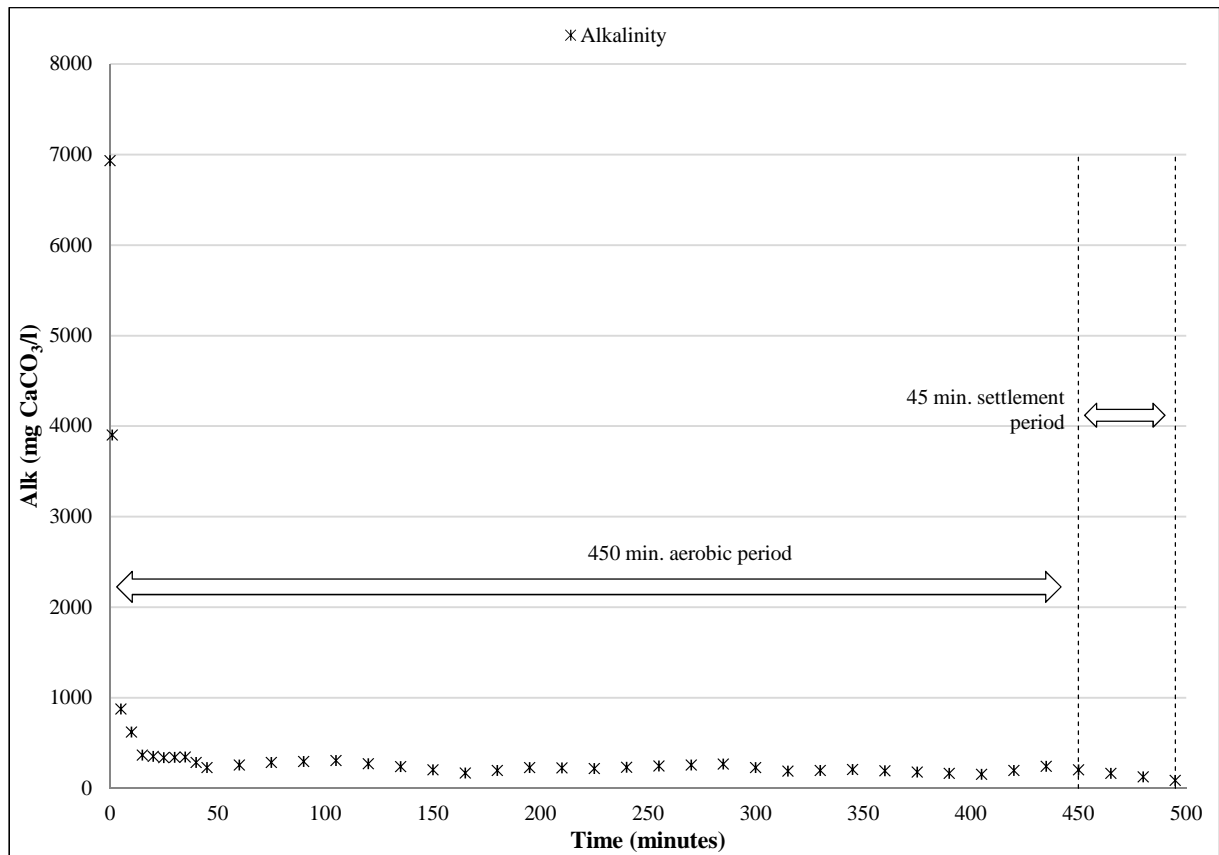

F 3.2.1 Influent landfill leachate - Study 3 - Phase 2

Date	Day No.	SS	COD	COD _f	TN	TN _f	NH ₄ -N	TON	NO ₂ -N	NO ₃ -N	PO ₄ -P	Alk
		mg/l	mg/l	mg/l	mg/l	mg/l	mg/l	mg/l	mg/l	mg/l	mg/l	mg/l
01/10/12	0.0	123	-	-	1314.8	1244.0	908.6	45.5	3.0	42.5	8.0	4643.1
02/10/12	1.0	560	1758	1710	1192.1	1084.7	942.4	49.3	27.3	22.0	7.5	4712.1
03/10/12	2.0	458	-	-	-	-	771.9	46.9	26.2	20.8	6.9	5298.0
04/10/12	3.0	400	1838	1702	1161.2	1077.9	775.6	33.0	1.3	31.6	7.5	5254.4
05/10/12	4.0	493	1832	1698	1189.6	1157.4	748.9	49.0	26.4	22.6	6.9	4517.5
10/10/12	9.0	345	1856	1702	1139.2	1090.6	730.2	50.7	0.0	50.6	7.8	4237.6
11/10/12	10.0	305	1836	1712	1229.3	1125.5	768.4	43.3	1.6	41.7	7.8	4310.2
19/10/12	18.2	388	2038	1954	1200.5	1106.1	798.2	41.1	30.4	10.7	8.2	5134.4
25/10/12	24.0	365	2082	1878	1187.2	1094.2	712.3	52.3	28.4	23.9	10.3	5056.4
30/10/12	29.0	275	2114	1968	1196.3	1127.4	776.2	54.9	27.6	27.3	9.4	5126.3
05/11/12	35.0	213	2106	1978	1175.6	1092.3	650.6	86.0	44.1	41.9	8.3	4991.8
06/11/12	36.2	215	-	-	1187.4	1077.1	622.6	60.6	20.4	40.2	1.8	4245.9
09/11/12	39.0	213	-	-	1176.0	1061.5	677.7	40.5	20.1	20.4	1.0	4358.4
14/11/12	44.0	195	2198	1912	1135.1	1089.4	719.2	43.5	19.2	24.3	1.4	4452.6
16/11/12	46.2	250	-	-	1162.7	1081.2	757.5	30.3	27.2	3.0	7.7	7496.1
19/11/12	49.2	228	-	-	1151.6	1032.6	673.3	38.6	33.6	5.0	6.6	6912.6
20/11/12	50.2	208	2846	2302	1187.0	1145.7	723.1	39.1	32.1	5.1	5.9	6812.3
26/11/12	56.0	443	3226	2880	1242.0	1116.2	712.7	69.3	51.5	17.7	0.8	4647.9
27/11/12	57.2	223	3542	3152	1212.6	1147.9	868.2	15.5	11.7	3.8	1.2	4382.0
05/12/12	65.2	318	3602	3168	1228.6	1168.8	823.7	58.3	48.5	9.7	0.8	4684.3
10/12/12	70.0	318	3388	2693	1233.0	1085.0	912.8	61.2	51.2	10.0	1.0	4514.3

F 3.2.2 Effluent landfill leachate - Study 3 - Phase 2

Date	Day No.	SS	COD	COD _f	TN	TN _f	NH ₄ -N	TON	NO ₂ -N	NO ₃ -N	PO ₄ -P	Alk
		mg/l	mg/l	mg/l	mg/l	mg/l	mg/l	mg/l	mg/l	mg/l	mg/l	mg/l
02/10/12	1.0	25	-	-	-	-	146.4	951.1	489.0	462.1	0.4	351.3
03/10/12	2.0	163	1740	1662	1182.8	1067.6	155.3	1082.7	626.2	456.5	0.2	408.1
03/10/12	2.2	158	-	-	1192.3	1101.1	154.7	1022.6	633.1	389.6	0.2	378.8
04/10/12	3.0	270	-	-	1183.2	1117.5	206.0	1062.4	602.0	460.4	0.4	425.2
05/10/12	4.0	350	1762	1660	1192.4	1107.0	155.8	1092.5	634.0	458.5	0.2	361.2
08/10/12	7.3	373	-	-	-	-	203.8	1046.4	662.6	383.8	0.4	487.8
09/10/12	8.0	123	1788	1662	-	-	165.8	1077.0	648.2	428.8	0.2	333.1
12/10/12	11.0	143	1802	1668	1201.1	1117.0	158.7	1050.8	667.2	383.7	0.3	261.5
17/10/12	16.0	130	1798	1668	1193.7	1131.7	-	-	-	-	-	-
17/10/12	16.3	113	-	-	1192.9	1128.1	159.6	1048.2	664.4	383.8	0.4	244.6
18/10/12	17.0	128	-	-	1185.1	1150.8	146.4	1037.8	754.8	283.0	1.1	241.8
19/10/12	18.0	145	-	-	1192.3	1148.5	144.7	1034.4	755.3	279.1	1.0	243.0
19/10/12	18.3	138	-	-	1181.0	1125.4	137.0	1055.1	760.1	295.1	1.1	238.3
22/10/12	21.2	148	-	-	1103.2	1083.9	128.6	1063.3	752.2	311.0	0.9	232.5
23/10/12	22.0	170	-	-	1105.5	1080.8	123.3	987.9	706.5	281.4	0.8	235.7
23/10/12	22.1	170	-	-	1120.5	1079.7	119.7	1006.5	718.5	288.0	0.9	231.8
25/10/12	24.0	108	2018	1902	1162.3	1087.3	146.0	983.1	705.5	277.5	0.4	290.9
25/10/12	24.3	223	-	-	1159.7	1058.8	128.1	1021.9	726.8	295.0	0.7	243.1
26/10/12	25.0	123	-	-	1109.4	1090.5	138.1	1043.9	740.5	303.4	0.5	248.0
30/10/12	29.0	130	-	-	1195.8	1117.7	128.1	1013.9	728.5	285.4	0.4	251.0
31/10/12	30.0	100	-	-	1188.0	1072.7	127.0	1045.1	753.1	292.1	0.9	231.3
01/11/12	31.0	133	2006	1954	1185.9	1037.3	122.1	1015.9	736.8	279.0	0.8	247.1
02/11/12	32.0	158	-	-	1181.5	993.7	121.3	979.9	701.5	278.4	0.9	230.7
05/11/12	35.2	165	-	-	1193.5	985.9	121.1	1013.9	721.8	292.0	0.4	246.1
12/11/12	42.3	205	1784	1718	1178.0	1061.1	132.4	966.9	746.3	220.7	0.5	249.7
14/11/12	43.9	185	2344	1934	1162.3	1079.3	145.9	933.2	728.9	204.3	0.4	277.3
15/11/12	45.0	200	-	-	1051.3	988.8	151.3	938.4	699.8	238.6	0.4	321.0

F 3.2.2 Effluent landfill leachate - Study 3 - Phase 2 (cont'd)

Date	Day No.	SS	COD	COD _f	TN	TN _f	NH ₄ -N	TON	NO ₂ -N	NO ₃ -N	PO ₄ -P	Alk
		mg/l	mg/l	mg/l	mg/l	mg/l	mg/l	mg/l	mg/l	mg/l	mg/l	mg/l
16/11/12	46.0	33	-	-	1074.0	1060.9	203.8	1121.1	932.4	188.7	0.3	353.6
16/11/12	46.2	243	-	-	1073.8	1026.9	194.7	1145.2	911.2	233.8	0.4	396.6
20/11/12	50.0	215	-	-	1096.4	1037.4	165.8	1425.8	1081.4	344.4	0.3	436.9
22/11/12	53.1	228	2588	2118	1092.6	1005.5	146.1	970.6	590.3	380.2	0.4	553.6
23/11/12	53.0	303	-	-	965.0	1072.1	158.1	1004.9	629.2	375.6	0.4	565.3
23/11/12	53.0	270	-	-	1000.6	974.6	156.7	871.1	513.3	357.8	0.4	952.3
27/11/12	56.9	253	2025	1948	1098.8	1074.4	157.6	852.3	511.7	340.6	0.6	1173.6
29/11/12	59.0	195	2706	2202	1076.8	1000.3	151.0	851.1	493.2	357.9	0.3	1119.3
30/11/12	60.0	250	-	-	952.6	928.4	149.9	741.8	409.8	332.0	0.4	1265.3
05/12/12	65.2	313	-	-	1108.8	1076.4	155.6	849.3	506.7	342.6	0.6	1362.6
11/12/12	71.3	145	2192	1899	1071.8	990.3	156.6	851.3	508.7	342.6	0.5	1353.6
12/12/12	72.0	273	2189	1845	1068.6	978.2	159.2	849.4	510.1	339.3	0.6	1371.2
13/12/12	73.0	123	-	-	1078.5	1024.3	158.8	851.2	501.3	349.9	0.7	1382.9

F 3.2.3.1 Study 3 - Phase 2a – LLIS 6

	min.	COD _f mg/l	TN mg/l	TN _f mg/l	NH ₄ -N mg/l	TON mg/l	NO ₂ -N mg/l	NO ₃ -N mg/l	PO ₄ -P mg/l	Alk mg/l
90 min. anoxic period	Inf.	1782	1083.9	1013.6	892.3	1.9	4.8	-3.0	8.2	3216
	1				208.8	1113.7	715.2	398.5	0.8	688
	5	1706	917.8	913.9	179.0	1093.8	685.1	408.6	0.3	352
	10	1700			177.4	1128.8	661.4	467.4	0.3	339
	15		884.0	871.0	174.7	1117.8	698.6	419.3	0.3	338
	20	1736			173.7	1076.6	662.0	414.6	0.3	336
	25		877.6	867.1	171.4	1080.0	709.6	370.4	0.3	332
	30	1793			172.3	1091.4	725.2	366.2	0.3	332
	35		871.9	864.3	174.6	1128.5	699.2	429.3	0.3	336
	40				171.4	1059.1	665.7	393.4	0.3	327
	45	1750	879.0	845.7	170.2	1089.6	695.0	394.5	0.3	331
	50				170.5	1075.2	690.7	384.5	0.3	328
	55		843.7	829.1	171.4	1094.6	713.8	380.8	0.3	339
	60				171.1	1100.3	684.2	416.0	0.3	325
	65		853.9	839.2	172.4	1086.7	707.7	379.0	0.3	330
	70				169.0	1065.3	681.2	384.2	0.3	332
	75		842.5	797.8	168.2	1101.6	700.1	401.5	0.3	330
	80				173.9	1090.3	702.1	388.1	0.3	333
	85		862.5	830.7	175.7	1065.1	728.2	336.9	0.3	353
	90	1768			174.1	1080.4	688.7	391.7	0.3	362
450 min. aerobic period	105		849.3	828.6	173.3	1083.8	665.4	418.4	0.2	361
	120				174.4	1070.1	677.7	392.4	0.3	355
	135		825.2	818.7	172.1	1081.8	684.2	397.7	0.3	354
	150				173.2	1102.5	702.2	400.3	0.2	353
	165		837.1	821.1	170.8	1087.9	682.4	405.5	0.3	349
	180	1724			169.7	1095.1	711.1	383.9	0.3	352
	195		852.9	850.3	169.4	1092.5	723.6	368.9	0.2	346
	210				176.2	1072.5	660.3	412.2	0.3	344
	225		840.4	832.7	175.3	1082.1	651.5	430.6	0.2	348
	240				172.3	1069.7	645.8	424.0	0.2	340
	255		858.5	855.1	178.1	1076.4	677.4	398.9	0.2	340
	270				175.8	1087.7	673.6	414.1	0.2	344
	285		864.2	847.4	171.7	1066.8	669.5	397.3	0.3	339
	300	1767			173.3	1054.8	661.6	393.2	0.2	338
	315		848.7	831.8	172.2	1086.9	668.7	418.2	0.2	334
	330				171.8	1080.8	658.6	422.2	0.2	338
	345		861.1	805.5	169.5	1076.2	693.9	382.3	0.2	334
	360	1812			168.6	1070.0	686.8	383.2	0.2	337
	375		858.0	828.9	168.1	1070.8	665.1	405.7	0.2	334
	390				173.0	1142.2	678.2	464.1	0.2	328
405		854.5	833.4	169.3	1146.2	670.2	476.0	0.2	327	
420		869.7	842.6	171.5	1151.0	681.1	469.9	0.2	328	

F 3.2.3.1 Study 3 - Phase 2a – LLIS 6 (cont'd)

	min.	COD_f mg/l	TN mg/l	TN_f mg/l	NH₄-N mg/l	TON mg/l	NO₂-N mg/l	NO₃-N mg/l	PO₄-P mg/l	Alk mg/l
A	435		865.9	847.7	169.3	1120.8	656.8	464.0	0.2	327
S	450		846.5	812.8	161.7	1154.3	620.3	534.0	0.2	321
	465		842.5	823.7	164.7	1117.0	656.9	460.1	0.2	322
Eff.	480	1814	872.9	829.3	169.9	1139.7	667.1	472.6	0.2	323

A – Aerobic period cont'd; S – 25minute aerobic period

F 3.2.3.2 Study 3 - Phase 2b – LLIS 6

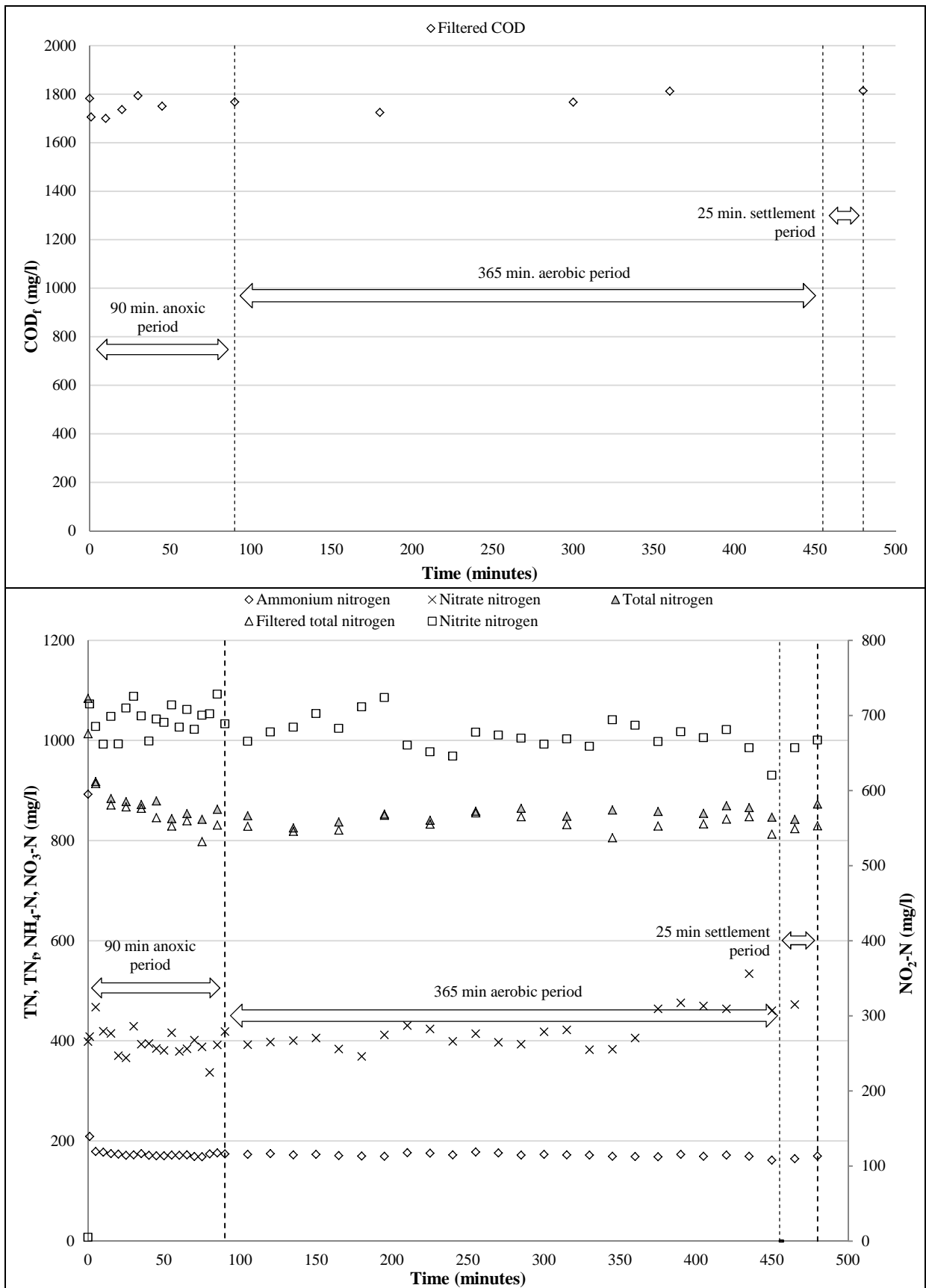

F 3.2.3.2 Study 3 - Phase 1 – LLIS 6 (cont'd)

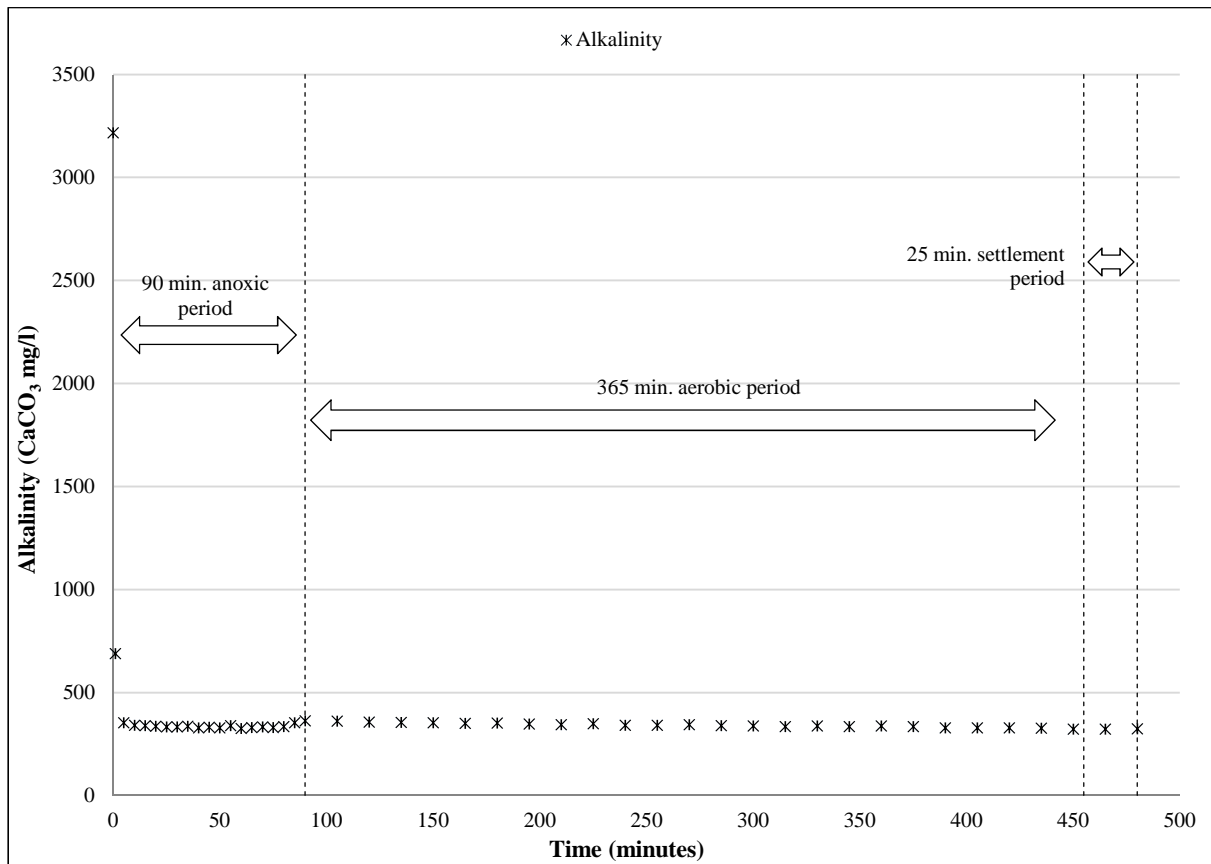

F 3.2.4.1 Study 3 - Phase 1 – LLIS 7

	min.	COD _f mg/l	TN mg/l	TN _f mg/l	NH ₄ -N mg/l	TON mg/l	NO ₂ -N mg/l	NO ₃ -N mg/l	PO ₄ -P mg/l	Alk mg/l
90 min. anoxic period	Inf.	1894	1365.3	1215.9	831.5	42.6	41.7	0.9	7.5	5758
	0		1297.8	1213.8	242.4	912.0	674.6	237.4	1.4	864
	5	1870	1229.8	1132.3	144.0	1073.1	755.5	317.6	0.6	289
	10		1228.2	1126.6	137.3	1069.1	755.5	313.5	0.6	272
	15		1228.7	1130.9	133.6	1053.6	743.1	310.5	0.4	276
	20		1224.1	1124.9	135.3	1072.9	750.0	322.9	0.4	279
	25	1874	1223.5	1128.8	138.4	1068.2	754.7	313.5	0.7	281
	30		1219.4	1126.5	139.8	1043.9	761.1	282.8	0.6	287
	35		1218.4	1124.3	137.3	1056.8	742.0	314.8	0.6	283
	40	1861	1218.3	1122.0	138.0	1052.0	748.2	303.8	0.7	286
	45		1193.3	1119.8	137.9	1048.9	748.6	300.3	0.6	286
	50		1185.0	1111.1	136.0	1059.4	755.8	303.6	0.6	288
	55		1176.8	1112.5	140.4	1044.5	767.2	277.3	0.7	290
	60	1848	1174.9	1105.0	139.9	1043.7	775.6	268.1	0.6	292
	65		1173.1	1107.5	138.7	1071.4	773.8	297.6	0.6	294
	70		1177.3	1106.8	132.4	1032.4	744.7	287.7	0.6	296
	75	1808	1174.4	1106.1	138.3	1048.1	760.8	287.3	0.6	299
	80		1171.4	1105.4	136.4	1007.9	727.6	280.2	0.6	297
	85		1172.5	1101.7	136.8	1037.3	751.6	285.8	0.6	296
	90	1788	1164.8	1099.9	136.1	1047.0	737.3	309.7	0.6	297
450 min. aerobic period	105		1172.1	1107.1	134.2	1040.1	763.7	276.4	0.6	268
	120		1193.4	1106.8	134.2	1054.0	766.3	287.7	0.6	252
	135	1783	1184.7	1104.5	137.8	1068.5	794.4	274.1	0.6	253
	150		1196.7	1150.5	131.6	1054.9	770.3	284.6	0.6	251
	165		1178.7	1116.6	129.7	1029.7	748.8	280.9	0.5	246
	180		1203.6	1121.2	132.8	1037.0	742.2	294.8	0.5	243
	195	1778	1208.5	1115.8	137.1	1082.7	775.5	307.2	0.6	250
	210		1212.6	1113.6	136.9	1031.1	761.6	269.4	0.6	243
	225		1214.7	1117.5	134.4	1014.7	751.8	262.9	0.5	245
	240		1199.6	1126.5	129.3	1030.3	730.4	299.9	0.5	243
	255	1772	1184.6	1127.5	130.5	1044.8	747.9	296.9	0.5	243
	270		1188.5	1123.8	133.2	1054.3	749.4	304.9	0.6	244
	285		1182.5	1120.1	131.6	1050.1	745.9	304.2	0.5	240
	300		1178.8	1119.0	135.8	1048.3	766.9	281.4	0.5	243
315	1766	1175.1	1115.9	135.5	1064.9	743.2	321.7	0.5	238	
330		1171.2	1113.2	132.5	1073.3	746.6	326.8	0.5	239	
345	1767	1167.4	1110.6	130.3	1073.1	747.3	325.8	0.5	239	
360		1160.5	1107.9	129.3	1072.9	747.1	325.8	0.5	240	
375		1155.5	1105.4	127.6	1069.6	745.4	324.2	0.5	238	
390	1768	1147.6	1101.7	127.1	1083.0	750.4	332.6	0.5	235	
405		1143.9	1099.0	127.3	1083.5	749.1	334.4	0.5	235	
420	1767	1138.2	1096.6	126.9	1084.6	749.6	335.0	0.5	233	

F 3.2.4.1 Study 3 - Phase 2b – LLIS 7 (cont'd)

	min.	COD_f mg/l	TN mg/l	TN_f mg/l	NH₄-N mg/l	TON mg/l	NO₂-N mg/l	NO₃-N mg/l	PO₄-P mg/l	Alk mg/l
A	435	1766	1137.0	1089.8	126.8	1085.6	750.3	335.3	0.5	233
S	450		1132.2	1082.7	125.9	1086.9	746.2	340.7	0.6	234
	465		1128.4	1080.4	125.4	1086.8	747.3	339.5	0.5	233
Eff.	480	1768	1124.8	1083.7	125.3	1085.1	743.5	341.6	0.6	245

A – Aerobic period cont'd; S – 25minute aerobic period

F 3.2.4.2 Study 3 - Phase 2b – LLIS 7

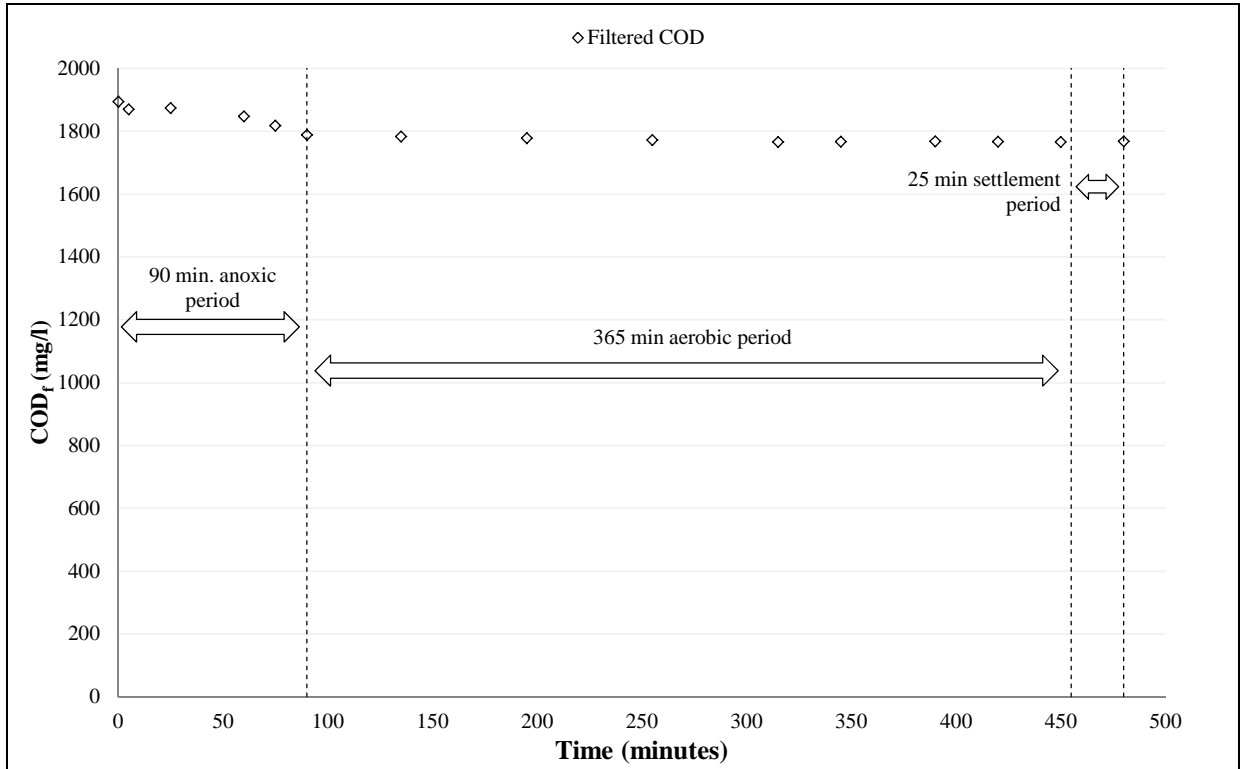

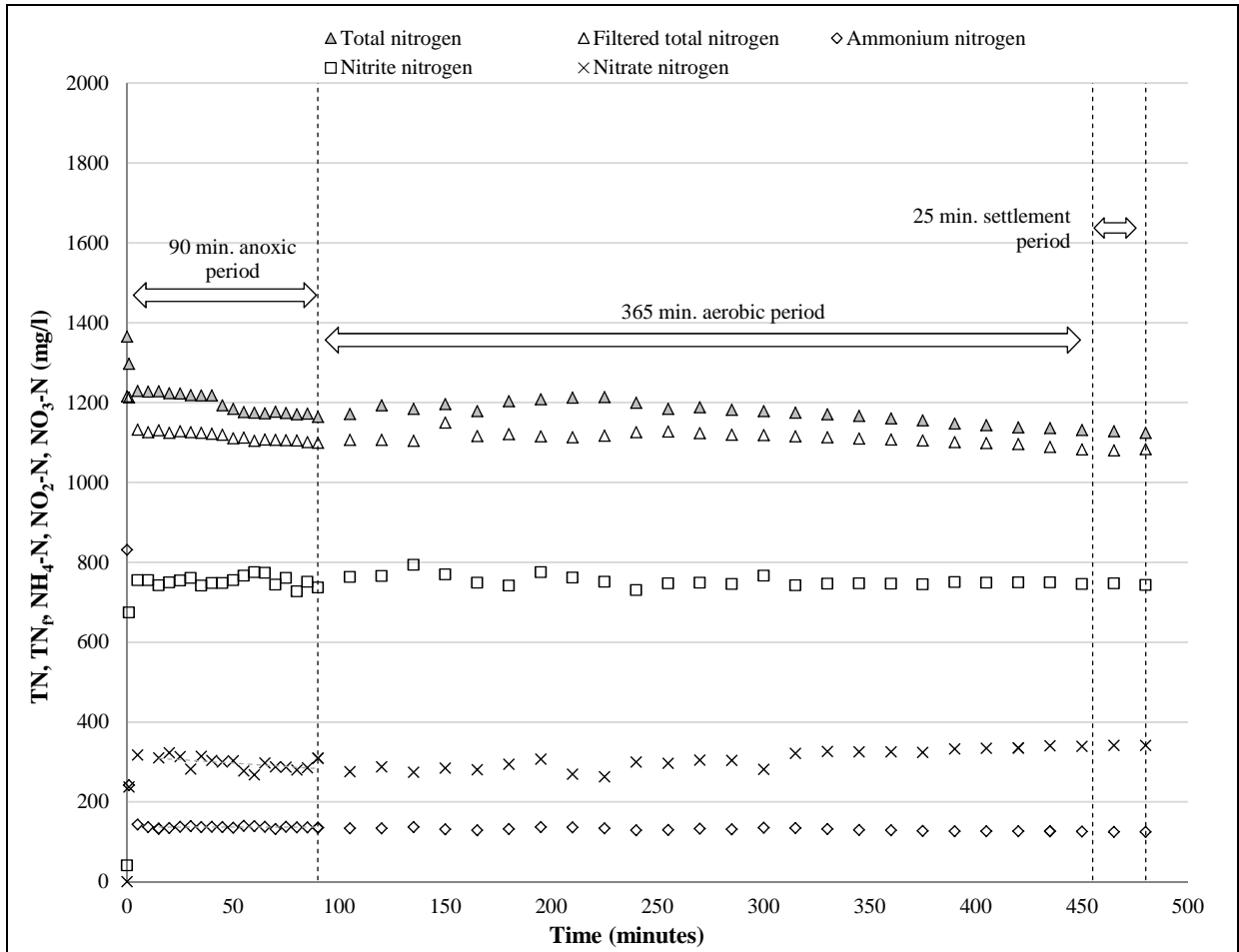

F 3.2.4.2 Study 3 - Phase 2b – LLIS 7 (cont'd)

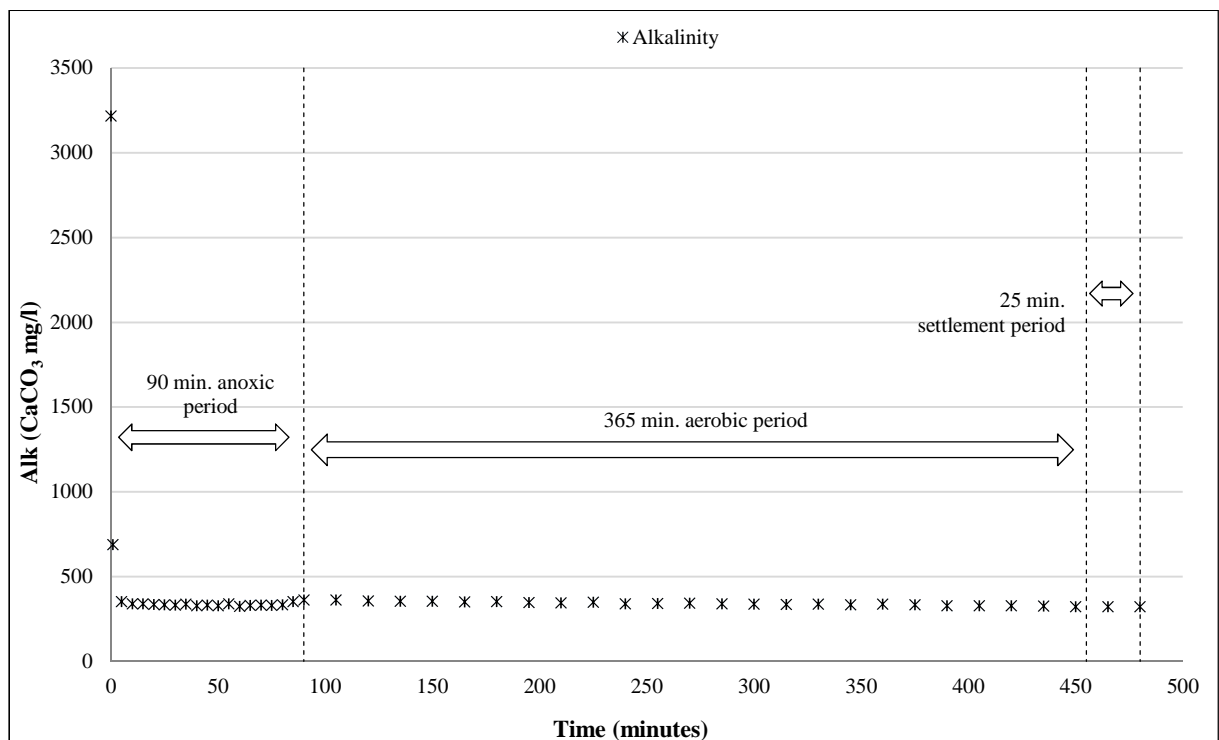

F 3.2.5.1 Study 3 - Phase 2b – LLIS 8

	min.	COD _f mg/l	TN mg/l	TN _f mg/l	NH ₄ -N mg/l	TON mg/l	NO ₂ -N mg/l	NO ₃ -N mg/l	PO ₄ -P mg/l	Alk mg/l
90 min. anoxic period	Inf.	2116	1356.7	1185.4	944.7	41.0	40.7	0.3	1.9	3726
	0		1183.7	1182.0	168.7	935.1	733.7	201.4	0.2	305
	1	2072	1151.7	1119.2	158.6	973.0	739.6	233.4	0.3	273
	5		1147.2	1112.3	157.8	965.9	737.6	228.3	0.3	276
	10		1142.6	1105.3	156.6	972.2	748.5	223.7	0.4	279
	15	1988	1137.9	1111.3	154.6	961.6	733.7	228.0	0.4	278
	20		1133.1	1117.2	155.5	965.2	743.5	221.7	0.3	279
	25		1131.9	1116.0	154.5	957.7	729.2	228.5	0.4	292
	30		1130.6	1114.8	154.5	957.7	738.7	218.9	0.5	282
	35		1131.4	1117.7	154.7	967.7	743.7	224.0	0.4	285
	40	2004	1132.2	1120.6	153.2	969.2	743.6	225.6	0.3	287
	45		1130.2	1118.7	150.9	945.3	721.9	223.4	0.3	286
	50		1128.2	1116.8	151.2	962.6	742.2	220.4	0.4	288
	55		1124.1	1112.9	154.2	973.5	742.3	231.2	0.3	286
	60	1992	1120.1	1108.9	151.2	968.2	740.6	227.6	0.3	287
	65		1116.7	1106.3	152.4	958.4	733.8	224.6	0.4	289
	70		1113.4	1103.7	152.4	948.5	721.4	227.1	0.3	291
	75		1103.6	1095.9	153.0	956.3	728.7	227.6	0.3	289
	80		1093.8	1088.2	154.8	959.9	730.4	229.5	0.3	292
	85		1094.7	1086.1	156.3	958.8	731.0	227.8	0.3	297
90	1998	1107.6	1088.0	154.2	960.2	727.1	233.1	0.3	288	
95		1116.0	1091.9	154.7	943.7	718.5	225.2	0.3	286	
100	1988	1124.4	1095.8	153.1	973.2	733.5	239.7	0.3	283	
105		1113.6	1098.3	155.7	969.9	728.0	241.9	0.2	282	
110		1102.8	1100.8	154.1	962.1	731.0	231.1	0.2	276	
115	1989	1099.3	1090.5	153.7	967.2	734.2	233.0	0.3	276	
120		1095.7	1080.1	154.0	964.2	734.8	229.4	0.3	276	
125		1103.1	1076.3	153.5	969.4	738.6	230.8	0.3	273	
130	1990	1110.4	1072.5	154.5	958.4	722.2	236.2	0.4	273	
135		1110.9	1064.9	152.3	979.9	727.8	252.1	0.4	269	
140		1114.0	1057.3	159.2	959.0	733.5	225.5	0.3	265	
145		1106.9	1073.2	155.8	947.8	724.0	223.8	0.4	263	
150	1986	1109.8	1079.1	153.4	959.8	719.1	240.7	0.3	259	
155		1108.9	1081.9	158.6	978.4	735.7	242.8	0.3	256	
160		1106.1	1074.7	150.1	964.3	727.7	236.6	0.3	252	
165	1990	1106.0	1074.2	151.7	971.7	744.9	226.9	0.3	250	
170		1102.2	1079.7	147.0	971.6	740.4	231.1	0.3	248	
175		1104.9	1078.6	146.8	976.7	741.7	235.0	0.3	243	
180	1987	1101.1	1081.8	151.0	975.2	747.0	228.2	0.3	244	
185		1097.8	1075.1	144.3	964.3	733.6	230.7	0.4	239	
190	1984	1093.9	1076.7	143.8	968.5	740.6	229.4	0.4	236	
195		1088.9	1074.9	142.5	970.0	726.9	241.6	0.4	234	
200										

F 3.2.5.1 Study 3 - Phase 2b – LLIS 8 (cont'd)

	min	COD_f mg/l	TN mg/l	TN_f mg/l	NH₄-N mg/l	TON mg/l	NO₂-N mg/l	NO₃-N mg/l	PO₄-P mg/l	Alk mg/l
A	435	1982	1087.7	1073.9	143.1	968.4	724.2	244.2	0.5	235
S	450	1984	1081.3	1074.3	144.7	970.1	724.7	245.4	0.4	236
	465		1098.0	1073.1	143.9	975.4	723.0	252.4	0.4	235
Eff.	480	1986	1097.0	1101.2	144.3	973.6	724.7	248.9	0.4	234

A – Aerobic period cont'd; S – 25minute aerobic period

F 3.2.5.2 Study 3 - Phase 2b – LLIS 8

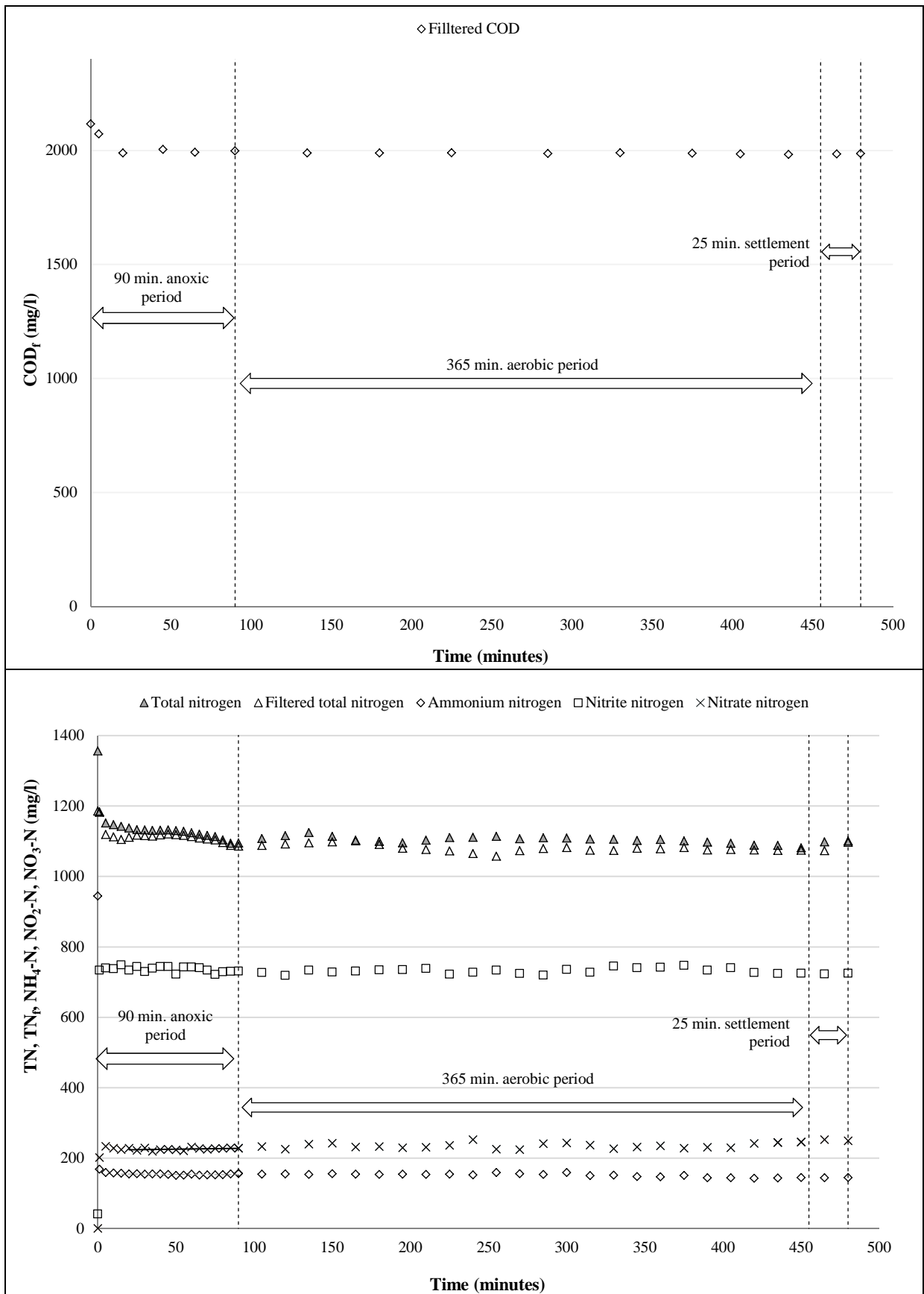

F 3.2.5.2 Study 3 - Phase 1b – LLIS 8 (cont'd)

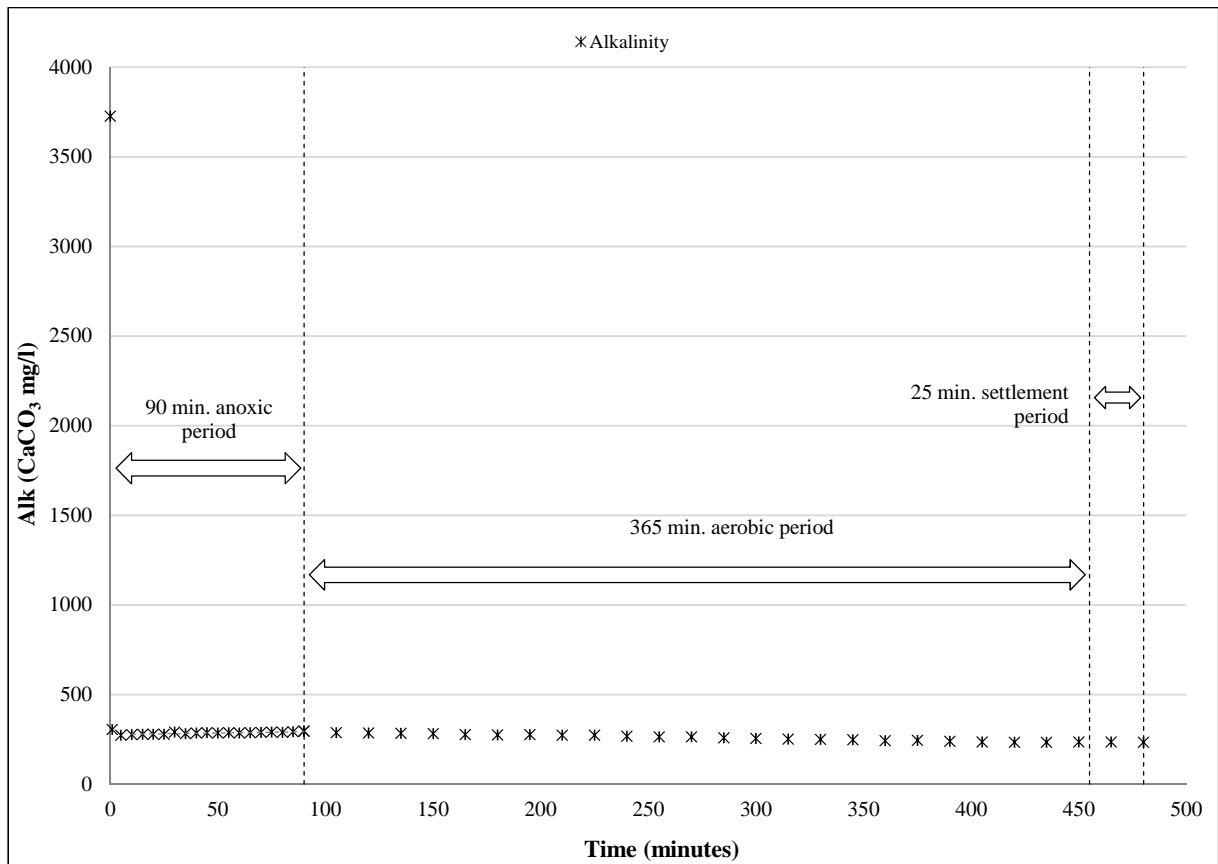

F 3.2.6.1 Study 3 - Phase 2c – LLIS 9

	min.	COD _f mg/l	TN mg/l	TN _f mg/l	NH ₄ -N mg/l	TON mg/l	NO ₂ -N mg/l	NO ₃ -N mg/l	PO ₄ -P mg/l	Alk mg/l
90 min. anoxic period	Inf.	3588	1128.9	1044.8	783.0	0.3	0.2	0.2	1.1	3005
	1	2380	1055.5	979.8	280.4	650.5	436.7	213.8	0.6	1846
	5	2360	977.5	906.6	175.0	724.8	498.1	226.7	0.2	1852
	10	2256	940.2	897.7	173.4	775.5	501.6	273.9	0.1	1858
	15		930.0	883.7	174.8	767.3	498.9	268.3	0.1	1859
	20		930.8	879.6	173.9	761.5	489.6	272.0	0.1	1861
	25		931.6	869.7	173.7	757.2	493.8	263.5	0.1	1863
	30		938.2	868.8	172.9	752.7	491.8	260.9	0.1	1868
	35	2208	944.7	866.3	173.8	746.1	506.4	239.7	0.1	1865
	40		943.1	880.9	173.5	742.3	500.5	241.8	0.1	1870
	45		941.4	876.3	173.0	734.6	517.3	217.4	0.1	1863
	50		936.4	871.6	172.7	727.0	503.8	223.2	0.1	1867
	55	2288	931.4	883.1	172.1	730.8	495.1	235.7	0.1	1870
	60		934.1	884.6	173.4	738.1	512.2	225.9	0.1	1871
	65		936.8	878.3	172.2	735.6	511.3	224.3	0.0	1874
	70		936.2	862.0	172.2	714.5	489.2	225.2	0.1	1876
	75		935.7	866.3	172.6	726.4	503.5	222.9	0.0	1879
	80		931.2	870.7	172.0	727.0	503.0	224.0	0.1	1879
	85	2158	926.7	876.2	172.9	724.2	506.7	217.5	0.1	1879
	90		924.6	875.6	172.9	713.6	497.6	216.0	0.1	1885
105		922.5	885.1	170.0	716.5	482.2	234.3	0.1	1881	
120		925.3	888.6	170.9	733.7	506.9	226.8	0.1	1820	
135	2172	928.2	881.3	171.1	737.1	512.7	224.4	0.0	1876	
150		931.9	873.9	171.5	728.0	493.8	234.2	0.0	1856	
165		935.6	866.9	167.2	722.7	501.1	221.6	0.0	1848	
180	2173	925.7	869.9	168.2	729.3	495.6	233.7	0.2	1848	
195		915.8	873.3	168.8	725.8	502.3	223.6	0.2	1846	
210		921.4	896.7	172.4	733.7	513.2	220.5	0.1	1822	
225	2174	927.0	895.0	167.3	710.1	488.2	221.9	0.0	1847.6	
240		928.1	892.3	170.7	723.2	500.7	222.5	0.1	1813.0	
255	2146	949.2	892.3	168.1	724.2	509.5	214.7	0.1	1807.6	
270		943.9	889.4	156.2	720.8	504.2	216.5	0.1	1780.5	
285		948.7	885.1	153.8	709.6	490.8	218.8	0.0	1782.1	
300	2118	941.3	882.9	172.7	719.9	495.7	224.2	0.0	1781.6	
315		944.4	879.7	153.2	725.4	510.1	215.3	0.0	1787.0	
330		920.2	879.9	147.2	727.8	499.9	227.8	0.1	1784.2	
345	2178	914.3	877.4	163.3	729.9	502.7	227.1	0.1	1783.7	
360		916.9	875.9	164.6	734.0	507.8	226.2	0.1	1779.1	
375		919.6	871.3	163.0	737.1	504.6	232.5	0.0	1773.0	
390		916.0	873.0	162.4	741.3	513.0	228.3	0.0	1774.7	
405		925.6	872.9	162.5	743.7	516.3	227.5	0.1	1773.0	
420	2128	922.0	870.6	161.4	748.5	508.9	239.6	0.1	1777.7	

F 3.2.6.2 Study 3 - Phase 2c – LLIS 9 (cont'd)

	min.	COD_f mg/l	TN mg/l	TN_f mg/l	NH₄-N mg/l	TON mg/l	NO₂-N mg/l	NO₃-N mg/l	PO₄-P mg/l	Alk mg/l
A	435		914.6	868.0	161.4	750.7	508.6	242.1	0.2	1769.6
S	450	2126	913.7	866.7	162.3	753.0	515.3	237.7	0.0	1765.9
	465		912.7	865.0	159.5	754.9	515.3	239.6	0.1	1767.0
Eff.	480	2124	910.1	864.7	157.4	755.3	517.2	238.1	0.1	1764.4

A – Aerobic period cont'd; S – 25minute aerobic period

F 3.2.6.2 Study 3 - Phase 2c – LLIS 9

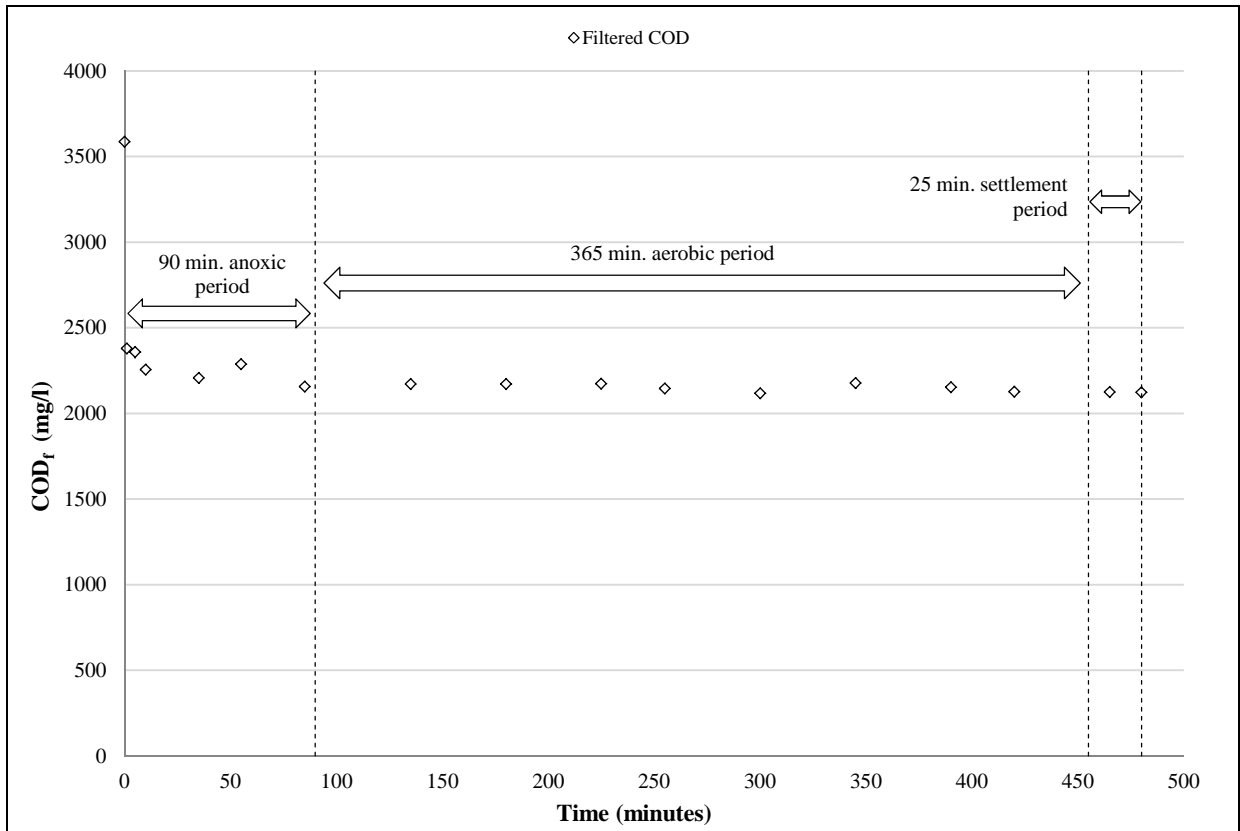

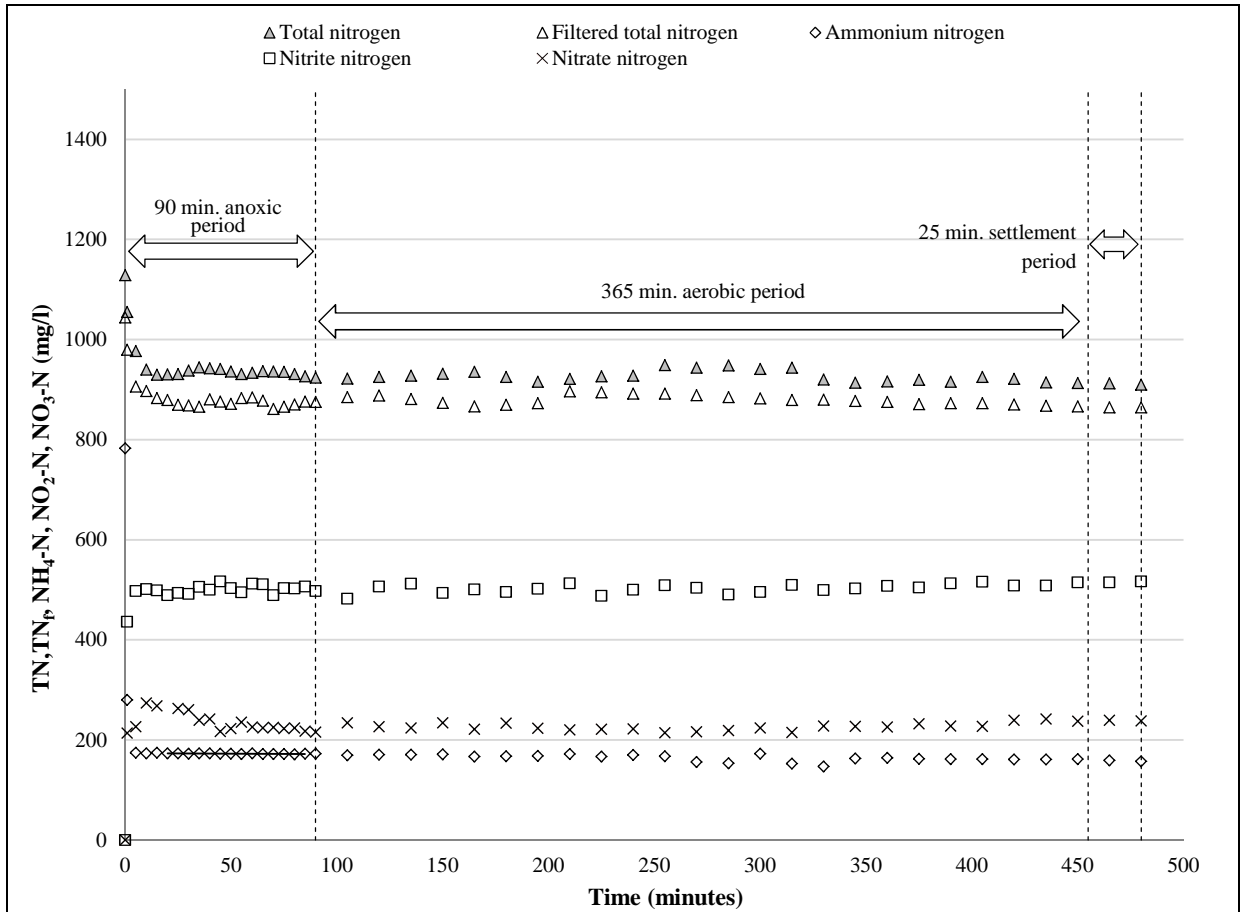

F 3.2.6.2 Study 3 - Phase 2c – LLIS 9 (cont'd)

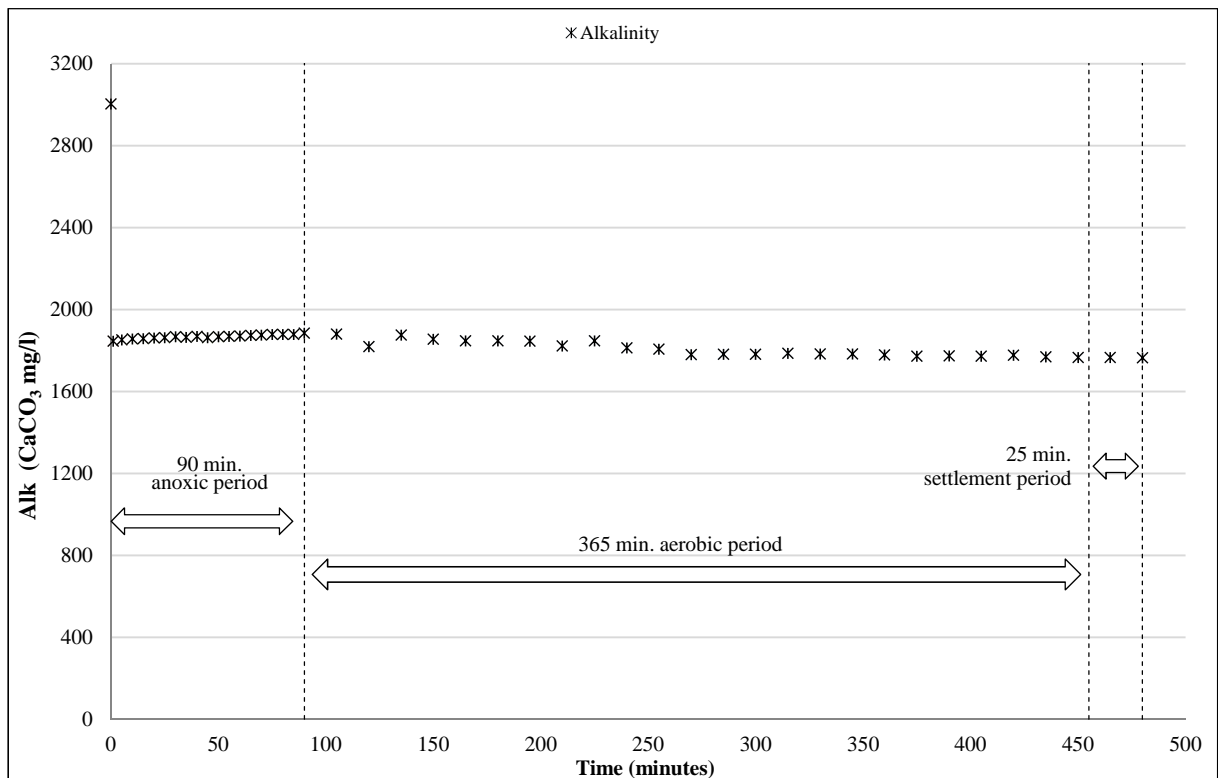

F 3.2.7.1 Study 3 - Phase 2c – LLIS 10

	min.	COD _f mg/l	TN mg/l	TN _f mg/l	NH ₄ -N mg/l	TON mg/l	NO ₂ -N mg/l	NO ₃ -N mg/l	PO ₄ -P mg/l	Alk mg/l	
90 min. anoxic period	Inf.	0	3256	1266.7	1235.4	944.7	1.0	0.7	0.3	1.9	3726
	1	2288	1114.3	1112.6	168.7	839.1	633.7	205.4	0.2	2290	
	5		1070.5	1053.5	158.6	860.0	637.6	222.4	0.3	2259	
	10	2224	1064.8	1033.3	153.3	855.9	637.6	218.3	0.3	2272	
	15		1059.2	1013.2	152.6	852.2	636.5	215.7	0.4	2276	
	20		1057.4	1025.6	149.6	851.6	636.7	215.0	0.4	2280	
	25	1996	1055.7	1038.0	151.5	850.2	637.5	212.7	0.3	2272	
	30		1046.3	1030.1	153.5	857.7	637.2	220.5	0.4	2274	
	35		1037.0	1022.1	154.5	857.7	638.7	218.9	0.5	2320	
	40	2012	1030.9	1018.0	152.7	861.7	643.7	218.0	0.4	2286	
	45		1024.9	1013.9	153.2	859.2	643.6	215.6	0.3	2292	
	50		1036.6	1025.8	150.9	855.3	640.9	214.4	0.3	2319	
	55	2074	1048.3	1037.6	151.2	852.6	640.2	212.4	0.4	2310	
	60		1037.7	1030.5	154.2	863.5	642.3	221.2	0.3	2304	
	65		1027.1	1023.4	152.2	858.2	640.6	217.6	0.3	2295	
	70		1023.9	1015.5	152.4	848.4	633.8	214.6	0.4	2314	
	75		1020.7	1007.5	152.4	848.5	628.4	220.1	0.3	2308	
	80		1019.1	1004.3	153.0	845.3	628.7	216.6	0.3	2314	
85		1017.4	1001.1	154.8	842.9	630.4	212.5	0.3	2289		
90	2054	1020.0	1005.8	152.9	841.8	631.0	210.8	0.3	2290		
365 min. aerobic period	105		1032.6	1010.5	153.2	850.2	617.1	233.1	0.3	2289	
	120		1030.5	1017.8	154.7	843.7	618.5	225.2	0.3	2282	
	135	2046	1028.4	1015.1	157.1	863.2	633.5	229.7	0.3	2278	
	150		1028.3	1010.7	155.7	869.9	628.0	241.9	0.2	2279	
	165		1023.1	1006.2	154.1	832.1	641.0	191.1	0.2	2281	
	180		1034.8	1002.5	153.7	837.2	644.2	193.0	0.3	2286	
	195	2036	1021.4	1001.7	154.0	854.2	644.8	209.4	0.3	2282	
	210		1018.3	1003.2	153.5	849.4	635.6	213.8	0.3	2292	
	225		1015.3	999.6	154.5	838.4	622.2	216.2	0.4	2262	
	240		1018.5	1002.4	152.3	879.9	627.8	252.1	0.4	2284	
	255		1013.7	995.3	159.2	859.0	633.5	225.5	0.3	2286	
	270	2024	1021.9	999.2	155.8	847.8	624.0	223.8	0.4	2275	
	285		1014.0	1003.1	153.4	859.8	619.1	240.7	0.3	2217	
	300		1012.3	997.9	158.6	878.4	635.7	242.8	0.3	2265	
	315		1010.6	991.6	150.1	849.3	627.7	221.6	0.3	2273	
	330		1036.4	1025.7	151.7	871.7	644.9	226.9	0.3	2262	
	345	2016	1016.0	1010.3	147.0	861.6	664.4	197.1	0.3	2233	
	360		1009.1	993.7	146.8	861.7	647.7	214.0	0.3	2243	
375		1009.2	998.6	151.0	859.2	647.0	212.2	0.3	2246		
390	1996	1005.2	1002.4	144.3	864.3	633.6	230.7	0.4	2236		
405		1004.9	989.9	146.8	873.5	640.6	235.4	0.4	2227		
420		994.5	975.2	145.5	876.0	641.9	231.6	0.4	2232		

F 3.2.7.1 Study 3 - Phase 2c – LLIS 10 (cont'd)

	min.	COD_r mg/l	TN mg/l	TN_r mg/l	NH₄-N mg/l	TON mg/l	NO₂-N mg/l	NO₃-N mg/l	PO₄-P mg/l	Alk mg/l
A	435		992.6	979.4	146.1	880.4	644.2	236.2	0.5	2228
S	450	2012	983.5	979.6	146.7	883.1	641.7	241.4	0.4	2224
	465		993.5	988.3	143.9	885.4	642.0	243.4	0.4	2226
Eff.	480	2008	992.4	983.8	144.3	887.6	642.7	244.9	0.4	2223

A – Aerobic period cont'd; S – 25minute aerobic period

F 3.2.7.2 Study 3 - Phase 2c – LLIS 10

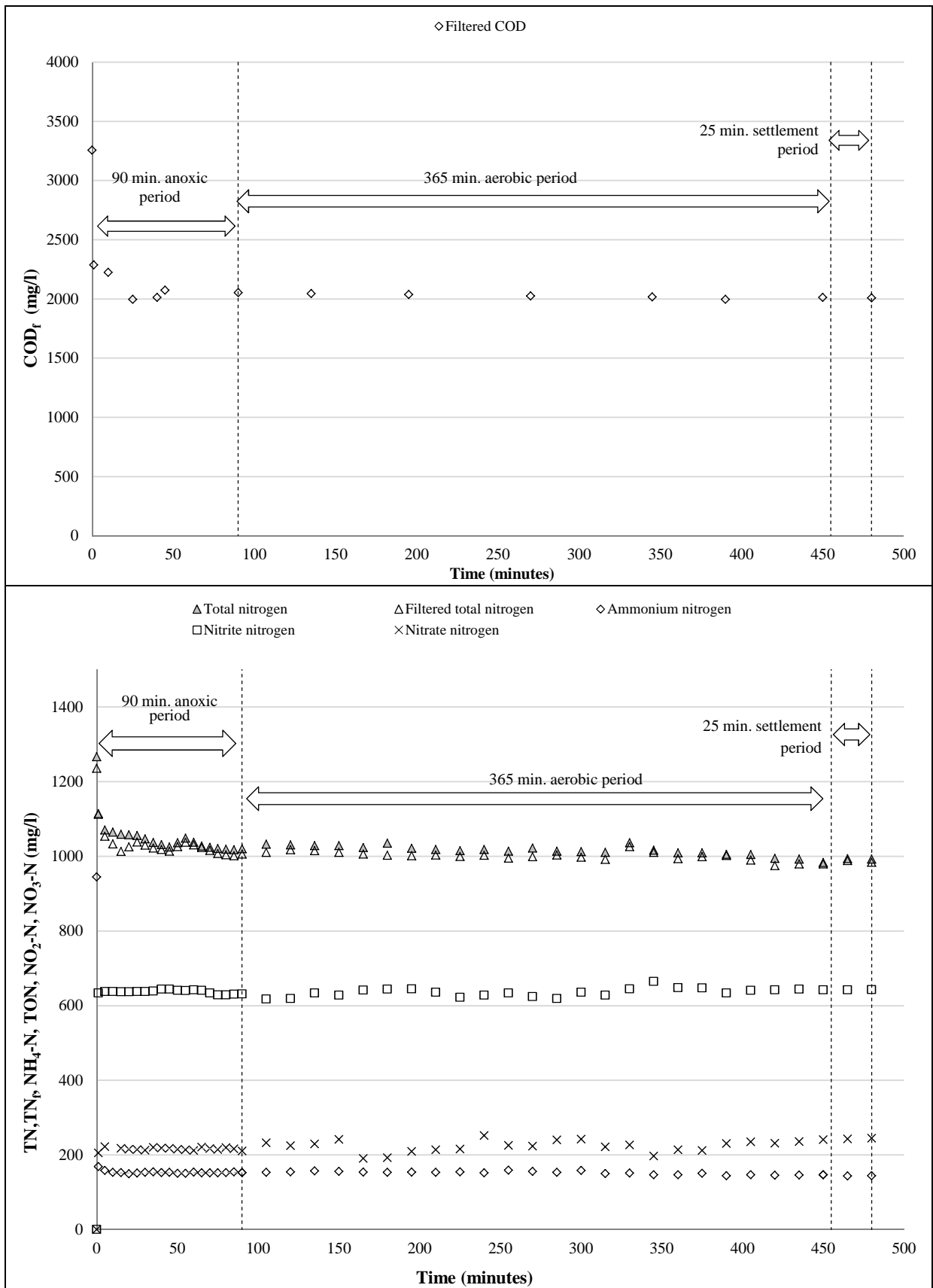

F 3.2.7.2 Study 3 - Phase 2c – LLIS 10 (cont'd)

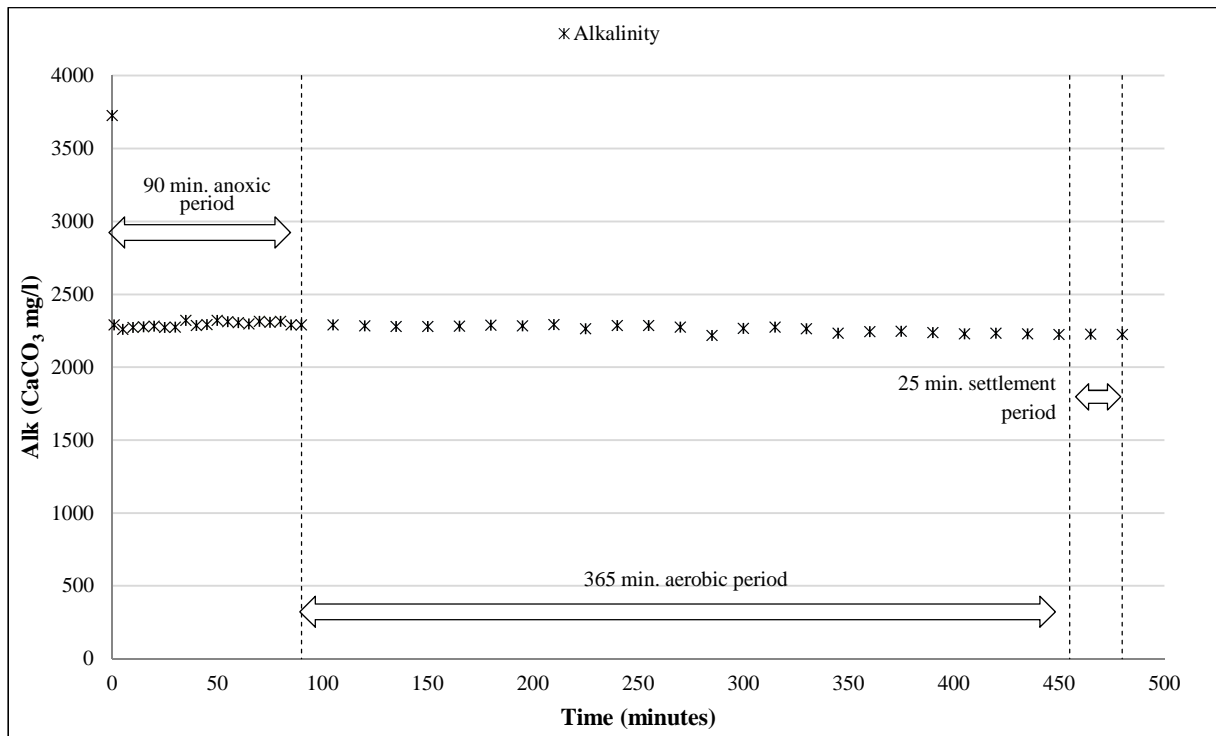

APPENDIX G

Nitrous oxide study data

G 1.1 Study 3 - Phase 2a

		MWIS 4	MWIS 5	MWIS 6
		N ₂ O mg/l	N ₂ O mg/l	N ₂ O mg/l
90 min. anoxic period	Inf.	0	0	0
	0	0	0	0
	1	0	0	0
	5	0.0019	0.0019	0.0019
	10	0.0038	0.0019	0.0028
	15	0.0076	0.0057	0.0066
	20	0.0113	0.0076	0.0094
	25	0.0132	0.0113	0.0123
	30	0.0132	0.0113	0.0123
	35	0.0151	0.0132	0.0142
	40	0.0151	0.0151	0.0151
	45	0.0151	0.0170	0.0160
	50	0.0170	0.0170	0.0170
	55	0.0170	0.0189	0.0179
	60	0.0170	0.0189	0.0179
	65	0.0170	0.0208	0.0189
	70	0.0170	0.0170	0.0170
	75	0.0189	0.0189	0.0189
	80	0.0189	0.0189	0.0189
	85	0.0208	0.0208	0.0208
90	0.0189	0.0189	0.0189	
185 min. aerobic period	105	0.0170	0.0132	0.0151
	120	0.0170	0.0113	0.0142
	135	0.0170	0.0038	0.0104
	150	0.0170	0	0.0085
	165	0.0170	0	0.0085
	180	0.0170	0	0.0085
	195	0.0170	0	0
	210	0	0	0
	225	0	0	0
	240	0	0	0
S	255	0	0	0
	272	0	0	0
	282	0	0	0
	292	0	0	0
Eff	300	0	0	0

S – 25 minute settlement period

G 1.2 Study 2 - Phase 2b

		MWIS 7	MWIS 8
	min.	N ₂ O mg/l	N ₂ O mg/l
Inf.	0	0	0
90 min. anoxic period	1	0	0
	5	0	0
	10	0	0
	15	0.0070	0.0070
	20	0.0080	0.0089
	25	0.0089	0.0109
	30	0.0099	0.0119
	35	0.0089	0.0129
	40	0.0089	0.0139
	45	0.0099	0.0149
	50	0.0089	0.0149
	55	0.0089	0.0149
	60	0.0109	0.0159
	65	0.0109	0.0149
	70	0.0109	0.0149
	75	0.0109	0.0159
	80	0.0109	0.0159
	85	0.0119	0.0159
90	0.0119	0.0119	
185 min. aerobic period	105	0.0119	0.0080
	120	0.0099	0.0040
	135	0	0
	150	0	0
	165	0	0
	180	0	0
	195	0	0
	210	0	0
	225	0	0
	240	0	0
S	272	0	0
	282	0	0
	292	0	0
Eff.	300	0	0

S – 25 minute settlement period

G 1.3 Study 3 - Phase 2b

		LLIS 7	LLIS 10
	min.	N ₂ O mg/l	N ₂ O mg/l
90 min. anoxic period	Inf.	0	0.0114
	1	0.0019	0.0152
	5	0.0057	0.0152
	10	0.0076	0.0189
	15	0.0057	0.0189
	20	0.0057	0.0152
	25	0.0057	0.0189
	30	0.0076	0.0152
	35	0.0114	0.0152
	40	0.0114	0.0152
	45	0.0152	0.0114
	50	0.0189	0.0114
	55	0.0152	0.0152
	60	0.0189	0.0152
	65	0.0152	0.0152
	70	0.0152	0.0152
	75	0.0152	0.0152
	80	0.0152	0.0152
	85	0.0152	0.0189
90	0.0152	0.0417	
365 min. aerobic period	105	0.0303	0.0379
	120	0.0341	0.0341
	135	0.0379	0.0379
	150	0.0379	0.0379
	165	0.0360	0.0379
	180	0.0379	0.0341
	195	0.0341	0.0341
	210	0.0341	0.0303
	225	0.0303	0.0303
	240	0.0284	0.0265
	255	0.0284	0.0227
	270	0.0265	0.0246
	285	0.0265	0.0208
	300	0.0227	0.0208
	315	0.0189	0.0208
	330	0.0189	0.0170
	345	0.0170	0.0170
360	0.0189	0.0170	
375	0.0170	0.0170	
390	0.0170	0.0170	
405	0.0152	0.0170	
420	0.0152	0.0170	

G 1.1 Study 3 - Phase 2b (cont'd)

		LLIS 7	LLIS 10
	min.	N₂O mg/l	N₂O mg/l
A	435	0	0.0170
S	450	0	0
	465	0	0
Eff.	480	0	0

A – Aerobic period cont'd; S – 25minute aerobic period

F 3.2.7.1 Study 1 - Phase 2c

		LLIS 9	LLIS 10
	min.	N₂O mg/l	N₂O mg/l
Inf.	0	0	0
90 min. anoxic period	1	0.0341	0.0227
	5	0.0284	0.0265
	10	0.0303	0.0303
	15	0.0246	0.0265
	20	0.0227	0.0189
	25	0.0208	0.0189
	30	0.0189	0.0189
	35	0.0208	0.0227
	40	0.0189	0.0189
	45	0.0227	0.0189
	50	0.0227	0.0152
	55	0.0208	0.0152
	60	0.0227	0.0170
	65	0.0246	0.0189
	70	0.0246	0.0189
	75	0.0208	0.0170
	80	0.0265	0.0170
	85	0.0284	0.0170
90	0.0265	0.0227	
365 min. aerobic period	105	0.1212	0.0871
	120	0.1156	0.0796
	135	0.1137	0.0871
	150	0.0890	0.0796
	165	0.0833	0.0758
	180	0.0909	0.0720
	195	0.0815	0.0682
	210	0.0758	0.0606
	225	0.0720	0.0644
	240	0.0682	0.0530
	255	0.0720	0.0455
	270	0.0739	0.0417
	285	0.0663	0.0398
	300	0.0720	0.0379
	315	0.0568	0.0341
	330	0.0682	0.0379
	345	0.0720	0.0398
	360	0.0606	0.0379
	375	0.0625	0.0379
	390	0.0644	0.0303
405	0.0568	0.0265	
420	0.0682	0.0227	

F 3.2.7.1 Study 1 - Phase 2c – LLIS 10 (cont'd)

		LLIS 9	LLIS 10
	min.	N₂O mg/l	N₂O mg/l
A	435	0.0625	0.0227
S	450	0.0530	0
	465	0	0
Eff.	480	0	0

A – Aerobic period cont'd; S – 25minute aerobic period